

CITY OF KENT

SURFACE WATER DESIGN MANUAL



July 21, 2022

ACKNOWLEDGEMENTS

This Manual is based on the 2021 King County Surface Water Design Manual.

Individuals involved in the preparation, review, or approval of this Kent Surface Water Design Manual are as follows:

Mayor

Dana Ralph

Kent City Council

Toni Troutner

Bill Boyce

Brenda Fincher

Zandria Michaud

Satwinder Kaur

Marli Larimer

Les Thomas

Interim Chief Administrative Officer

Pat Fitzpatrick

Public Works Director

Chad Bieren, P.E.

Deputy Public Works Director, Engineering

Kelly Peterson

Environmental Engineering Manager

Mike Mactutis, P.E.

Project Manager

Laura Haren

Technical Review

Mike Mactutis, P.E.

Dave Brock, P.E.

Brennan Taylor, P.E.

Shawn Gilbertson

Stephen Lincoln, P.E.

Erin George

GIS Mapping

Jim Cordova

Sarah Burns

Document Production

Nancy Yoshitake

PREFACE

HOW TO USE THIS DOCUMENT



CITY OF KENT Surface Water Design Manual 2022

The city of Kent has adopted the 2021 King County Surface Water Design Manual (KCSWDM) as amended by this document. This document includes all changes, additions, and deletions to the KCSWDM and is to be used for all development, as applicable, within the city of Kent.

In the event a conflict exists between the King County Surface Water Design Manual and the Kent Surface Water Design Manual, Kent City Code, or Kent Design and Construction Standards, Kent standards and code will generally control. The applicant must notify city review staff if conflicts are discovered.

CITY EQUIVALENTS FOR COUNTY AGENCIES AND ORDINANCES

For proposals located within the City of Kent, all references in the KCSWDM to the following King County departments are to be replaced by reference to the Kent Economic and Community Development Department:

- DDES (Department of Development and Environmental Services)
- DNR (Department of Natural Resources)
- SWM (Surface Water Management)
- WLR (Water and Land Resources)

For proposals in the City of Kent, all references in the KCSWDM to the King County Sensitive Areas Ordinance (SAO) are to be replaced by reference to the Kent City Code, particularly Chapters 11, 14, and 15.

COUNTY DESIGNATIONS THAT DO NOT APPLY IN THE CITY

The following designations are used in the 2021 KCSWDM but are not currently used in the City of Kent; any reference in the KCSWDM to the existence of areas with these designations or thresholds or requirements for such areas is to be disregarded for development applications within the City of Kent:

- Coal Mine Hazard Area
- Critical Drainage Area
- Rural Residential Development
- Shared Facility

MANUAL UPDATES

With a publication of this complexity there may be errors that must be corrected and clarifications that are needed. There will also be new information and technological updates. The City of Kent Department of Public Works intends to publish corrections, updates and new technical information on our Departmental Home Page at <http://www.kentwa.gov/stormwater/>. The web site will not be used to make revisions in key policy areas – such as the thresholds and minimum requirements in Chapter 1. We encourage you to visit this web site periodically and incorporate updates and corrections into your copies of the manual. You can also visit this web site for updates and additional information about other Kent Public Works surface water activities.

ADDENDUM ORGANIZATION

The information presented in this document is organized as follows:

- **Preface—How to Use This Document:** This preface provides instructions for using the City of Kent’s SWDM. It also defines terms in the King County manual that are used differently for the City of Kent; City departments that are equivalent to county departments referred to in the KCSWDM; and designations from the King County manual that do not apply to proposals in the City of Kent.
- **Chapter 1—Drainage Review Requirements:** A completely revised Chapter 1 has been provided in this document. It is to be used instead of Chapter 1 in the 2021 KCSWDM for all proposals in the City of Kent. This chapter sets forth the thresholds and requirements for drainage review, describes the three types of drainage review, and summarizes the nine Core and five Special Requirements.
- **Chapter 2—Drainage Plan Submittal:** A completely revised Chapter 2 has been provided in this document. It is to be used instead of Chapter 2 in the 2021 KCSWDM for all proposals in the City of Kent. This chapter describes the required format and components of submittals for the three types of drainage review.
- **Chapter 3—Hydrologic Analysis and Design:** The City of Kent has made no changes to Chapter 3 of the 2021 KCSWDM. The King County version of Chapter 3 applies for proposals in the City of Kent.
- **Chapter 4—Conveyance System Analysis and Design:** The City of Kent has made several minor changes to Chapter 4 of the 2021 KCSWDM. This chapter provides replacement text for the sections that are changed. Apart from these changes, the King County version of Chapter 4 applies for proposals in the City of Kent.
- **Chapter 5—Flow Control Design:** The City of Kent has made minor changes to Chapter 5 of the 2021 KCSWDM. This chapter provides replacement text for the section that is changed. Apart from these changes, the King County version of Chapter 5 applies to proposals in the City of Kent.
- **Chapter 6—Water Quality Design:** The City of Kent has made a few minor changes to Chapter 6 of the 2021 KCSWDM. This chapter provides replacement text for the section that is changed. Apart from this change, the King County version of Chapter 6 applies to proposals in the City of Kent.
- **Appendices** – Appendix A presents the City of Kent **Maintenance Requirements for Privately Maintained Drainage Facilities** (reprinted from Appendix D of the Kent Construction Standards), there is no Appendix B (King County includes Master Drainage Plan requirements here – does not apply in Kent), Appendices C and D are the Small Site Drainage Requirements and Erosion and Sediment Control Standards, respectively. These are included as separately bound documents included with the King County Manual.
- **References** - The City of Kent accepts certain reference materials as written in the 2021 King County Surface Water Design Manual. Other references are not applicable in Kent. Some reference materials have been revised to reflect Kent-specific forms or development procedures. References from the King County Manual are identified below along with how they are to be utilized in Kent (in bold).

TABLE OF CONTENTS



CITY OF KENT
Surface Water Design Manual
2022

TABLE OF CONTENTS

PREFACE..... v

 City Equivalents For County Agencies And Ordinances.....vi

 County Designations That Do Not Apply In The Cityvi

 Manual Updatesvi

 Addendum Organization.....vi

TABLE OF CONTENTS.....xi

KEY TERMS AND DEFINITIONSxiv

CHAPTER 1..... 1-0

1 Drainage Review and Requirements..... 1-1

 1.1 Drainage Review..... 1-1

 1.1.1 Projects Requiring Drainage Review 1-3

 1.1.2 Drainage Review Types and Requirements 1-4

 1.1.3 Drainage Design Beyond Minimum Compliance 1-12

 1.2 Core Requirements 1-13

 1.2.1 Core Requirement #1: Discharge at The Natural Location 1-13

 1.2.2 Core Requirement #2: Offsite Analysis 1-15

 1.2.3 Core Requirement #3: Flow Control Facilities 1-26

 1.2.4 Core Requirement #4: Conveyance System..... 1-41

 1.2.5 Core Requirement #5: Erosion and Sediment Control..... 1-45

 1.2.6 Core Requirement #6: Maintenance and Operations 1-52

 1.2.7 Core Requirement #7: Financial Guarantees and Liability 1-54

 1.2.8 Core Requirement #8: Water Quality 1-55

 1.2.9 Core Requirement #9: Flow Control BMPs 1-64

 1.3 Special Requirements..... 1-80

 1.3.1 Special Requirement #1: Other Adopted Area-Specific Requirements 1-80

 1.3.2 Special Requirement #2: Flood Hazard Area DELINEATION 1-81

 1.3.3 Special Requirement #3: Flood Protection Facilities 1-83

 1.3.4 Special Requirement #4: Source Controls 1-84

 1.3.5 Special Requirement #5: Oil Control..... 1-86

 1.4 Adjustment Process..... 1-89

 1.4.1 Adjustment Authority 1-89

 1.4.2 Criteria for Granting Adjustments 1-89

 1.4.3 Adjustment Application Process..... 1-93

 1.4.4 Adjustment Review Process..... 1-93

 1.4.5 Request For Reconsideration Procedure 1-95

CHAPTER 2..... 1-0

2 Drainage Plan Submittal 2-1

 2.1 Plans for Permits and Drainage Review..... 2-2

 2.1.1 Plans Required for initial permit Submittal..... 2-2

 2.1.2 Plans Required for drainage review 2-2

 2.2 Plans Required with Initial permit submittal 2-4

 2.2.1 Subdivisions, short plats and Binding site plans 2-4

 2.2.2 Commercial Site Development 2-6

 2.2.3 Single-family Residential..... 2-6

 2.2.4 Other Permits 2-6

 2.3 Plans Required for Drainage Review 2-7

 2.3.1 Engineering Plan Specifications 2-7

 2.3.2 Projects in Targeted Drainage Review 2-32

 2.4 Plans Required After Drainage Review 2-34

 2.4.1 Plan Changes After Permit Issuance 2-34

 2.4.2 Final Corrected Plan Submittal 2-34

 2.4.3 Final Plat, Short Plat, and Binding Site Plan Submittals..... 2-34

CHAPTER 3..... 2-37

3 Hydrologic Analysis and Design 3-1

CHAPTER 4..... 3-0

4 Conveyance System Analysis and Design 4-1

 4.1 Route Design Easement Requirements 4-1

4.1.1 Easement And Setback Requirements 4-1

4.2 Pipes, Outfalls, and Pumps 4-2

4.2.1 Pipe Systems 4-2

4.2.2 Outfall Systems 4-7

4.3 Culverts And Bridges..... 4-8

4.3.1 Culverts..... 4-8

CHAPTER 5 4-1

5 Flow Control Design..... 5-1

5.1 Detention Facilities 5-1

5.1.1 Detention Ponds 5-1

5.1.2 Detention Tanks 5-2

5.1.5 Parking Lot Detention 5-3

5.1.6 Roof Detention..... 5-3

CHAPTER 6 1

6 Water Quality Design 6-1

6.2 General Requirements For WQ Facilities 6-1

6.2.3 Slopes, And EMBANKMENTS 6-1

6.7 Proprietary Facility Designs 6-1

APPENDIX 6-3

APPENDIX A.....A-1

Appendix A - Maintenance Requirements For Flow Control, Conveyance, And water quality FacilitiesA-2

APPENDIX B.....A-3

Appendix B - Master Drainage Plan Objectives, Criteria, Components, And Review ProcessA-5

APPENDIX C.....A-7

Appendix C – Simplified Drainage Requirements.....A-9

APPENDIX D.....A-11

Appendix D – Construction Stormwater Pollution PreventionA-13

D.1 General CSWPP Requirements.....A-13

REFERENCESR-1

MAPSM-2

Erosion Hazard AreasM-2

Flow Control Applications.....M-2

Landslide Hazard / Landslide Hazard Drainage AreasM-3

Soils Wellhead Areas.....M-4

Water Quality ApplicationsM-5

WetlandsM-6

Lower Mill Creek Regulatory AreaM-7

KEY TERMS AND DEFINITIONS



CITY OF KENT Surface Water Design Manual 2022

KEY TERMS AND DEFINITIONS

A complete list of definitions follows Chapter 6.

Proper application of the drainage review and requirements in this chapter requires an understanding of the following key terms and their definitions. Other key terms may be defined in subsequent chapters. All such key terms are highlighted in bold italic throughout the manual. Other important terms that are not key terms are defined in the text when they are first introduced. These are highlighted in italic when they are first introduced but are not highlighted throughout the manual. All terms defined in this chapter are also found in the "Definitions" section of this manual as are other important terms defined throughout the Manual.

Acceptable discharge point: An enclosed drainage system (i.e., pipe system, culvert, or tightline) or open drainage feature (e.g., ditch, channel, swale, stream, river, pond, lake, or wetland) where concentrated runoff can be discharged without creating a significant adverse impact.

Agricultural project: any project located on, and proposing improvements consistent with, the permitted uses of land zoned for Agriculture.

Arterial: A high traffic-volume road or street primarily for through traffic. The term generally includes roads or streets considered collectors. It does not include local access roads which are generally limited to providing access to abutting property.

Base flood: The flood having a one percent chance of being equaled or exceeded in any given year. Also referred to as the "100-year flood". The base flood is determined for future flow conditions, except in areas where the FEMA Flood Insurance Study includes detailed base flood calculations. In that case, the FEMA data shall apply.

Bioretention: A flow control best management practice consisting of a shallow landscaped depression designed to temporarily store and promote infiltration of stormwater runoff. Standards for bioretention design, including soil mix, plants, storage volume and feasibility criteria, are specified in Appendix C.

Certified Erosion and Sediment Control Lead (CESCL): an individual who has current certification through an approved erosion and sediment control training program that meets the minimum training standards established by the Washington Department of Ecology Department (Ecology). The CESCL must have the skills to assess *site* conditions and construction activities that could impact the quality of stormwater and, the effectiveness of erosion and sediment control measures used to control the quality of stormwater discharges. Certification is obtained through an Ecology approved erosion and sediment control course.

City Review Staff: the City of Kent employee(s) responsible for the conditioning, review, inspection, and approval of development permits. This is generally staff from the Development Review section of the Economic and Community Development Department but may include other city employees such as Public Works staff.

Civil engineer: a person licensed by the state of Washington as a professional engineer in civil engineering.

Construct or modify: to install a new drainage pipe or ditch or make improvements to an existing drainage pipe or ditch, for purposes other than maintenance, which either serves to concentrate previously unconcentrated surface water or stormwater runoff or serves to increase, decrease or redirect the conveyance of surface water or stormwater runoff. "Construct or modify" does not include installation or maintenance of a driveway culvert installed as part of a single-family residential building permit.

Conveyance system nuisance problem: a flooding or erosion problem that does not constitute a ***severe flooding problem*** or ***severe erosion problem*** and that results from the overflow of a constructed conveyance system for runoff events less than or equal to a 10-year event. Examples include inundation of a shoulder or lane of a roadway, overflows collecting in yards or pastures, shallow flows across driveways, minor flooding of crawl spaces or unheated garages/outbuildings, and minor erosion.

Critical aquifer recharge area: the critical area designation, defined and regulated in KCC 11.06, which is applied to areas where extra protection of groundwater quantity and quality is needed because of known susceptibility to contamination and importance to drinking water supply. Such areas are delineated on the *King County Critical Aquifer Recharge Area Map* available at DPER or on the County's Geographic Information System (GIS). See the "Definitions" section for more details.

Development: any activity that requires a permit or approval, including, but not limited to, a building permit, grading permit, shoreline substantial development permit, conditional use permit, special use permit, zoning variance or reclassification, subdivision, short subdivision, urban planned development, binding site plan, site development permit, or right-of-way use permit. "Development" does not include a Class I, II or III, forest practice conducted in accordance with Chapter 76.09 RCW and Title 222 WAC.

Director: the Economic and Community Development Director or the Public Works Director as appropriate for the permit condition or other issue under consideration.

Drainage facilities: a constructed or engineered feature that collects, conveys, stores, treats, or otherwise manages surface water or stormwater runoff. "Drainage facility" includes, but is not limited to, a constructed or engineered stream, lake, wetland, or closed depression, or a pipe, channel, ditch, gutter, flow control facility, flow control BMP, water quality facility, erosion and sediment control facility, and any other structure and appurtenance that provides for drainage.

Effective impervious surface: impervious surfaces that are connected via sheet flow or discrete conveyance to a drainage system. Impervious surfaces are considered ineffective if: 1) the runoff is fully dispersed as described in Appendix C of this manual; 2) residential roof runoff is infiltrated in accordance with the full infiltration BMP described in Appendix C of this manual; or 3) approved continuous runoff modeling methods indicate that the entire runoff file is infiltrated.

Erodible or leachable materials, wastes, or chemicals: materials or substances that, when exposed to rainfall, measurably alter the physical or chemical characteristics of the rainfall runoff (Examples include but are not limited to erodible soil, uncovered process wastes, manure, fertilizers, oily substances, ashes, kiln dust, garbage dumpster leakage, commercial-scale vehicle and animal wash waste, galvanized structural, architectural, cabinet, and utility steel, architectural copper, bronze, brass, and lead, treated lumber, etc.).

Erosion hazard area: the critical area designation, defined and regulated in KCC 21A, that is applied to areas underlain by soils that are subject to severe erosion when disturbed. See the "Definitions" section for more details.

Existing flooding: Flooding over all lanes of the roadway or driveway has occurred in the past and can be verified by City records, City personnel, photographs, or other physical evidence.

Existing site conditions: shall mean the native vegetation and soils that existed at the site prior to the influence of Euro-American settlement. Existing site conditions outside of the Lower Mill Creek, Lower Springbrook Creek, Lower Garrison Creek or within the Green River Natural Resource Area as shown on the Flow Control Application Map shall be assumed to be forested land cover unless reasonable, historic information is provided that indicated that the site was prairie prior to settlement.

Exposed: subject to direct or blown-in precipitation and/or direct or blown in runoff. Not ***fully covered***.

Exposed area or exposed material: not covered sufficiently to shield from rainfall and stormwater runoff. At a minimum, full coverage to not be considered ***exposed*** requires a roof with enough overhang in conjunction with walls of sufficient height to prevent rainfall blow-in; and the walls must extend into the ground or to a berm or footing to prevent runoff from being blown in or from running onto the covered area.

Finished area: Any enclosed area of a building that is designed to be served by the building's permanent heating or cooling system.

Frequently Flooded area: the critical area designation, defined and regulated in KCC 11.06, which is applied to areas subject to inundation by a 100-year flood event or areas at risk from channel migration. Flood hazard areas generally include, but are not limited to, aquatic areas (e.g., streams or lakes), wetlands, or closed depressions. See the "Definitions" section for more details.

Floodway: the channel of the river or stream and those portions of the adjoining floodplains which are reasonably required to carry and discharge the base flood flow. The portions of the adjoining floodplains that are considered to be “reasonable required” are defined by the **City** flood hazard regulations as stated in Chapter 14 of the Kent City Code.

Flow control BMP: a small scale drainage facility or feature that is part of a development site strategy to use processes such as infiltration, dispersion, storage, evaporation, transpiration, forest retention, and reduced impervious surface footprint to mimic pre-developed hydrology and minimize stormwater runoff.

Flow duration: The aggregate time that peak flows are at or above a particular flow rate of interest (e.g., the amount of time over the last 40 years that peak flows were at or above the 2-year flow rate).

Full build-out conditions: The tributary area is developed to its full zoning potential except where there are existing **streams, lakes, wetlands, closed depressions, geologic hazard areas, or open space tracts.**

Fully covered: covered sufficiently to shield from rainfall and stormwater runoff. At a minimum, full coverage requires a roof with enough overhang in conjunction with walls of sufficient height to prevent rainfall blow-in; and the walls must extend into the ground or to a berm or footing to prevent runoff from being blown in or from running onto the covered area. Not **exposed.**

Fully dispersed the runoff from an impervious surface or non-native pervious surface has dispersed per the criteria for fully dispersed surface in Section 1.2.3.2.

Geologic Hazard Areas: Include Seismic Hazard Areas, Erosion Hazard Areas, and Landslide Hazard Areas.

Groundwater protection areas: include **critical aquifer recharge areas** as defined in KCC 11.06, sole source aquifer areas as designated by the federal Environmental Protection Agency, and wellhead protection areas as mapped by the Washington State Department of Health.

High-use site: that area within a commercial or industrial site that typically generates or is subject to runoff containing high concentrations of oil due to high traffic turnover, on-site vehicle or heavy or stationary equipment use, or the frequent transfer of liquid petroleum or coal derivative products.

High-use sites include:

1. That area of a commercial or industrial site that:
 - a) has an expected average daily traffic (ADT) count equal to or greater than 100 vehicles per 1,000 square feet of gross building area; or
 - b) is subject to petroleum storage or transfer in excess of 1,500 gallons per year, not including delivered heating oil at the end-user point of delivery; or
 - c) is subject to use, storage, or maintenance of a fleet of 25 or more diesel or jet fuel (aviation turbine fuel) vehicles that are over 10 tons net weight (trucks, buses, trains, airplanes, tugs, mobile and fuel-driven or hydraulic stationary heavy equipment, etc.); or
2. The interior of any road intersection and that portion of lanes leading into the intersection subject to braking, turning, or stopping, with a measured ADT count of 25,000 vehicles or more on the main roadway and 15,000 vehicles or more on any intersecting roadway. Projects proposing primarily pedestrian or bicycle use improvements are excluded.

Historic site conditions: those that existed on the **site** prior to any development in the Puget Sound region. For lands not currently submerged (i.e., outside the ordinary high water mark of a lake, wetland, or stream), historic site conditions shall be assumed to be forest cover unless reasonable, historic, **site**-specific information is provided to demonstrate a different vegetation cover. In Kent this area is designated by the Lower Mill Creek Regulatory Map. In some stream basins, as allowed per Section 1.2.3.1.B, historic site conditions for lands not currently submerged may be assumed to be 75% forest, 15% grass, and 10% impervious surface.

Impaired waterbody or impaired receiving water: where the receiving waterbody is either:

- (1) listed as impaired according to Ecology's Water Quality Assessment categories 2, 4, or 5 for water or sediment, as documented in the state's Water Quality Assessment 303(d)/305(b) Integrated Report and is displayed in WA Ecology's electronic database and map viewer of these waterbodies, or
- (2) is currently designated by the City as polluted based on credible data indicating exceedance or concern for exceedance of the state's numeric water quality standard as documented in the latest published list of King County-Identified WQ Problems (Reference Section 10) posted at <http://www.kingcounty.gov/environment/water-and-land/stormwater/documents/surface-water-design-manual.aspx>, or
- (3) where subject to any other local, state, or federal cleanup plan or contaminated site designation.

Impervious surface: a hard surface area that either prevents or retards the entry of water into the soil mantle as under natural conditions before development; or that causes water to run off the surface in greater quantities or at an increased rate of flow compared to the flow present under natural conditions prior to development (see also "new impervious surface"). Common impervious surfaces include, but are not limited to, roof, walkways, patios, driveways, parking lots, or storage areas, areas that are paved, graveled or made of packed or oiled earthen materials or other surfaces that similarly impede the natural infiltration of surface water or stormwater. For the purposes of applying the impervious surface thresholds and exemptions contained in this manual, permeable pavement, vegetated roofs, and pervious surfaces with underdrains designed to collect stormwater runoff are considered impervious surface while an open uncovered flow control or water quality facility is not. However, for the purposes of computing runoff, uncovered flow control or water quality facilities shall be modeled as impervious surfaces as specified in Chapter 3.

Land disturbing activity: any activity that results in a change in the existing soil cover, both vegetative and non-vegetative, or the existing soil topography. Land disturbing activities include, but are not limited to demolition, construction, clearing, grading, filling, excavation, and compaction. Land disturbing activity does not include tilling conducted as part of agricultural practices, landscape maintenance, or gardening.

Landscape management plan: a City of Kent approved plan for defining the layout and long-term maintenance of landscaping features to minimize the use of pesticides and fertilizers to reduce their discharge, and to reduce the discharge of suspended solids and other pollutants.

Landslide hazard area: the critical area designation, defined and regulated in KCC 11.06, which is applied to areas subject to severe risk of landslide due to topography, soil conditions, and geology.

Landslide hazard drainage area: an area mapped by the City of Kent where it has been determined that overland flows from a project will pose a significant threat to health and safety because of its close proximity to a **landslide hazard area** that is on a slope steeper than 15%. Such areas are delineated on the Landslide Hazard Drainage Areas map adopted with this manual.

Low Impact Development (LID): A stormwater and land use management strategy that strives to mimic pre-disturbance hydrologic processes of infiltration, filtration, storage, evaporation and transpiration by emphasizing conservation, use of on-site natural features, site planning, and distributed stormwater management practices that are integrated into a project design.

LID Best Management Practices: Distributed stormwater management practices, integrated into a project design, that emphasize pre-disturbance hydrologic processes of infiltration, filtration, storage, evaporation and transpiration. LID BMPs are referred to as flow control BMPs in this manual and include, but are not limited to, bioretention, permeable pavements, limited infiltration systems, roof downspout controls, dispersion, soil quality and depth, and minimal excavation foundations.

LID Principles: Land use management strategies that emphasize conservation, use of on-site natural features, and site planning to minimize impervious surfaces, native vegetation loss, and stormwater runoff.

Maintenance: those usual activities taken to prevent a decline, lapse, or cessation in the use of currently serviceable structures, facilities, BMPs, equipment, or systems if there is no expansion of any of these, and there are no significant hydrologic impacts. Maintenance includes the repair or replacement of non-functional facilities and BMPs, and the replacement of existing structures with different types of structures, if the repair or replacement is required to meet current engineering standards or is required by one or more environmental permits and the functioning characteristics of the original facility or structure are not changed. For the purposes of applying this definition to the thresholds and requirements of this manual, city review staff will

determine whether the functioning characteristics of the original facility, structure, or BMP will remain sufficiently unchanged to consider replacement as maintenance. Drainage review is not required for projects proposing only maintenance.

Note: The following pavement maintenance practices are not categorically exempt from drainage review: removing and replacing a paved surface to base course or lower (i.e. “replaced impervious surfaces”), extending the edge of pavement or paving graveled shoulders, or resurfacing that meets the definition of “new impervious surface” in this manual.

National Pollutant Discharge Elimination System (NPDES): the national program for issuing, modifying, revoking, reissuing, terminating, monitoring, and enforcing permits; and imposing and enforcing pretreatment requirements; under sections 307, 402, 318, and 405 of the federal CWA for the discharge of pollutants to surface waters of the state. These permits are referred to as NPDES permits, and in the state of Washington are administered by the Washington State Department of Ecology.

Native vegetated surface: a surface in which the soil conditions, ground cover, and species of vegetation are like those of the original native condition for the *site*. More specifically, (1) the soil is either undisturbed or has been treated according to the "native vegetated landscape" specifications in Appendix C, Section C.2.1.8; (2) the ground is either naturally covered with vegetation litter or has been top-dressed between plants with 4 inches of mulch consistent with the native vegetated landscape specifications in Appendix C; and (3) the vegetation is either (a) comprised predominantly of plant species, other than noxious weeds, that are indigenous to the coastal region of the Pacific Northwest and that reasonably could have been expected to occur naturally on the *site* or (b) comprised of plant species specified for a native vegetated landscape in Appendix C. Examples of these plant species include trees such as Douglas fir, western hemlock, western red cedar, alder, big-leaf maple and vine maple; shrubs such as willow, elderberry, salmonberry and salal; and herbaceous plants such as sword fern, foam flower, and fireweed.

Natural discharge area: an onsite area tributary to a single *natural discharge location*.

Natural discharge location: the location where surface and storm water runoff leaves (or would leave if not infiltrated or retained) the *site* or *project site* under *existing site conditions*.

Natural onsite drainage feature: A natural swale, channel, stream, closed depression, wetland, or lake.

New impervious surface: the addition of a hard or compacted surface like roofs, pavement, gravel, or dirt; or the addition of a more compacted surface, like paving over pre-existing dirt or gravel. Permeable pavement and vegetated roofs are considered new impervious surface for purposes of determining whether the thresholds for application of minimum requirements are exceeded, as are lawns, landscaping, sports fields, golf courses, and other areas that have modified runoff characteristics resulting from the addition of underdrains designed to collect stormwater runoff. Open, uncovered retention/detention facilities shall not be considered impervious surfaces for purposes of determining whether the thresholds for application of minimum requirements are exceeded. Open, uncovered retention/detention facilities shall be considered impervious surfaces for purposes of runoff modeling.

New pervious surface: the conversion of a *native vegetated surface* or other native surface to a non-native pervious surface (e.g., conversion of forest or meadow to pasture land, grass land, cultivated land, lawn, landscaping, bare soil, etc.), or any alteration of existing non-native pervious surface that significantly increases surface and storm water runoff (e.g., conversion of pasture land, grass land, or cultivated land to lawn, landscaping, or bare soil; or alteration of soil characteristics).

New PGIS: new impervious surface that is *pollution-generating impervious surface* or any alteration of existing pollution-generating impervious surface that changes the type of pollutants or results in increased pollution loads and/or concentrations.

New PGPS: new pervious surface that is *pollution-generating pervious surface* or any alteration of existing pollution-generating pervious surface that changes the type of pollutants or results in increased pollution loads and/or concentrations.

Permeable pavement: Pervious concrete, porous asphalt, permeable pavers or other forms of pervious or porous paving material intended to allow passage of water through the pavement section. It often includes an aggregate base that provides structural support and acts as a stormwater reservoir.

Pervious Surface: Any surface material that allows stormwater to infiltrate into the ground. Examples include lawn, landscape, pasture, and native vegetation areas. Note for purposes of threshold determination and runoff volume modeling for detention and treatment, vegetated roofs and permeable pavements are to be considered impervious surfaces along with lawns, landscaping, sports fields, golf courses, and other areas that have modified runoff characteristics resulting from the addition of underdrains.

Pollution-generating impervious surface (PGIS): an impervious surface considered to be a significant source of pollutants in stormwater runoff. Such surfaces include those that are *subject to vehicular use*, industrial activities, or storage of *erodible or leachable materials, wastes, or chemicals*, and that receive direct rainfall or the run-on or blow-in of rainfall. A covered parking area would be included if runoff from uphill could regularly run through it or if rainfall could regularly blow in and wet the pavement surface. PGIS includes metal roofs unless they are coated with an inert, non-leachable material (see Reference 11-E); or roofs that are exposed to the venting of significant amounts of dusts, mists, grease laden vapors/FOG, or fumes from manufacturing, commercial, or other indoor activities. PGIS includes vegetated roofs exposed to pesticides, fertilizers, or loss of soil. Other roofing types that may pose risk but are not currently regulated are listed in Reference 11-E. Lawns, landscaping, sports fields, golf courses, and other areas that have modified runoff characteristics resulting from the addition of underdrains that have the pollution generating characteristics described under the “pollution-generating pervious surface” definition are also considered *PGIS*.

Pollution-generating pervious surface (PGPS): a non-impervious surface considered to be a significant source of pollutants in surface and storm water runoff. Such surfaces include those that are *subject to vehicular use*, industrial activities, storage of *erodible or leachable materials, wastes, or chemicals*, and that receive direct rainfall or the run-on or blow-in of rainfall; or subject to use of pesticides and fertilizers, or loss of soil. Such surfaces include, but are not limited to, the lawn and landscaped areas of residential, commercial, and industrial sites or land uses, golf courses, parks, sports fields (natural and artificial turf), cemeteries, and City approved grassed modular grid pavement.

Project site: that portion of a *site* and any offsite areas subject to proposed project activities, alterations, and improvements including those required by this manual.

Rain Garden: A shallow, landscaped depression with compost-amended native soils and adapted plants. The depression is designed to pond and temporarily store stormwater runoff from adjacent areas, and to allow stormwater to pass through the amended soil profile.

Receiving waters: bodies of water, surface water systems, or groundwater receiving water from upstream man-made or natural systems.

Redevelopment project: a project that proposes to add, replace, or modify impervious surfaces for purposes other than a residential subdivision or maintenance on a *site* that is already substantially developed in a manner consistent with its current zoning or with a legal non-conforming use, or has an existing impervious surface coverage of 35% or more. The following examples illustrate the application of this definition.

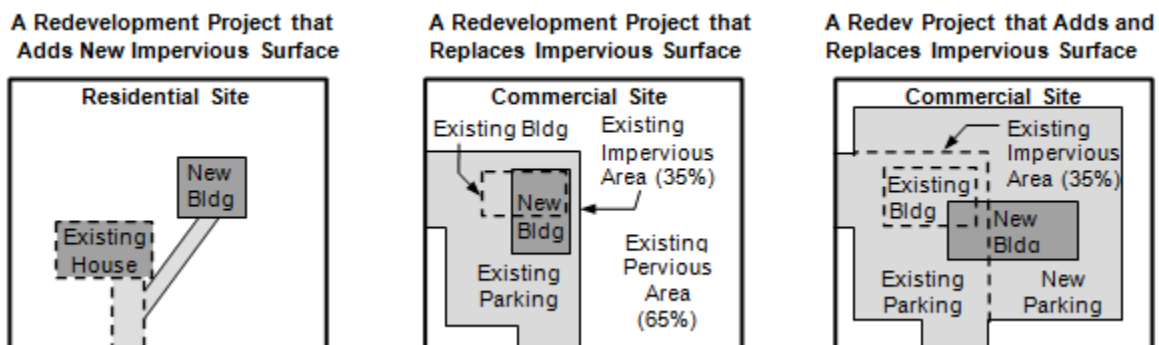

Replaced impervious surface: any existing impervious surface on the *project site* that is proposed to be removed and re-established as impervious surface, excluding impervious surface removed for the sole purpose of installing utilities or performing maintenance on underground infrastructure. For structures, *removed* means the removal of buildings down to the foundation. For other impervious surfaces, *removed* means the removal

down to base course or bare soil. For purposes of this definition, base course is the layer of crushed rock that typically underlies an asphalt or concrete pavement. It does not include the removal of pavement material through grinding or other surface modification unless the entire layer of PCC or AC is removed. Replaced impervious surface also includes impervious surface that is moved from one location to another on the project site where the following two conditions are met:

- (A) the area from which the impervious surface is moved from will be restored to the same or better runoff discharge characteristics as the area being covered by the moved impervious surface, and
- (B) impervious surface at the new location is either designated as non- pollution generating or the pollution generating characteristics remain unchanged compared to that of the original location.

Replaced PGIS: replaced impervious surface that is **pollution-generating impervious surface**.

Sensitive lake: a designation applied to lakes that are particularly prone to eutrophication from development-induced increases in phosphorus loading. The Water Quality Applications Map indicates the lakes within the City of Kent that are affected by this problem.

Severe building flooding problem: there is flooding of the *finished floor area*¹ of a *habitable building*,² or the electrical/heating system of a habitable building for runoff events less than or equal to a 100-year event. Examples include flooding of finished floors of homes and commercial or industrial buildings, or flooding of electrical/heating system components in the crawl space or garage of a home.

Severe erosion problem: there is an open drainage feature with evidence of or potential for erosion/incision sufficient to pose a sedimentation hazard to downstream conveyance systems or pose a landslide hazard by undercutting adjacent slopes. Severe erosion problems do not include roadway shoulder drilling or minor ditch erosion.

Severe flooding problem: a **severe building flooding problem** or a **severe roadway flooding problem**.

Severe roadway flooding problem: there is flooding over all lanes of a *roadway*,³ or a *sole access driveway*⁴ is severely impacted, for runoff events less than or equal to the 100-year event. A severely impacted sole access driveway is one in which flooding overtops a culverted section of the driveway, posing a threat of washout or unsafe access conditions due to indiscernible driveway edges, or flooding is deeper than 6 inches on the driveway, posing a severe impediment to emergency access.

Single family residential project: any project that (a) constructs or modifies a single family dwelling unit, (b) makes improvements (e.g., driveways, roads, outbuildings, play courts, etc.) or clears native vegetation on a lot that contains or will contain a single family dwelling unit, or (c) is a plat, short plat, or boundary line adjustment that creates or adjusts lots that will contain single family dwelling units.

Site: a single parcel; or, two or more contiguous parcels that are under common ownership or documented legal control; or a portion of a single parcel under documented legal control separate from the remaining parcel, used as a single parcel for a proposed project for purposes of applying for authority from the city of Kent to carry out

¹ *Finished floor area*, for the purposes of defining **severe building flooding problem**, means any enclosed area of a building that is designed to be served by the building's permanent heating or cooling system.

² *Habitable building* means any residential, commercial, or industrial building that is equipped with a permanent heating or cooling system and an electrical system.

³ *Roadway*, for the purposes of this definition, means the traveled portion of any public or private road or street classified as such City of Kent *Road Design and Construction Standards*.

⁴ *Sole access driveway* means there is no other unobstructed, flood-free route for emergency access to a habitable building.

a proposed project. For projects located primarily within dedicated rights-of-way, the length of the project site and the right-of-way boundaries define the site.

Steep slope hazard area: the critical area designation, defined and regulated in KCC 11.06 that is applied to areas on a slope of 40% or more within a vertical elevation change of at least 10 feet. See the "Definitions" section for more details.

Subject to vehicular use: the surface is regularly used by motor vehicles including but not limited to motorcycles, cars, trucks, busses, aircraft, tractors, and heavy equipment. The following surfaces are considered regularly used by motor vehicles: roads, un-vegetated road shoulders, bike lanes within the traveled lane of a roadway, driveways, parking lots, unrestricted access fire lanes, vehicular equipment storage yards, and airport taxiways and runways. The following surfaces are not considered regularly used by motor vehicles: paved bicycle pathways separated from and not subject to drainage from roads for motor vehicles, fenced or restricted access fire lanes, and maintenance access roads with a recurring use of no more than one routine vehicle access per week.

Threshold discharge area: an onsite area draining to a single *natural discharge location*, or multiple *natural discharge locations* that combine within one-quarter-mile downstream (as determined by the shortest flowpath). The examples below illustrate this definition. This term is used to clarify how the thresholds, exemptions, and exceptions of this manual are applied to *sites* with multiple discharge locations.

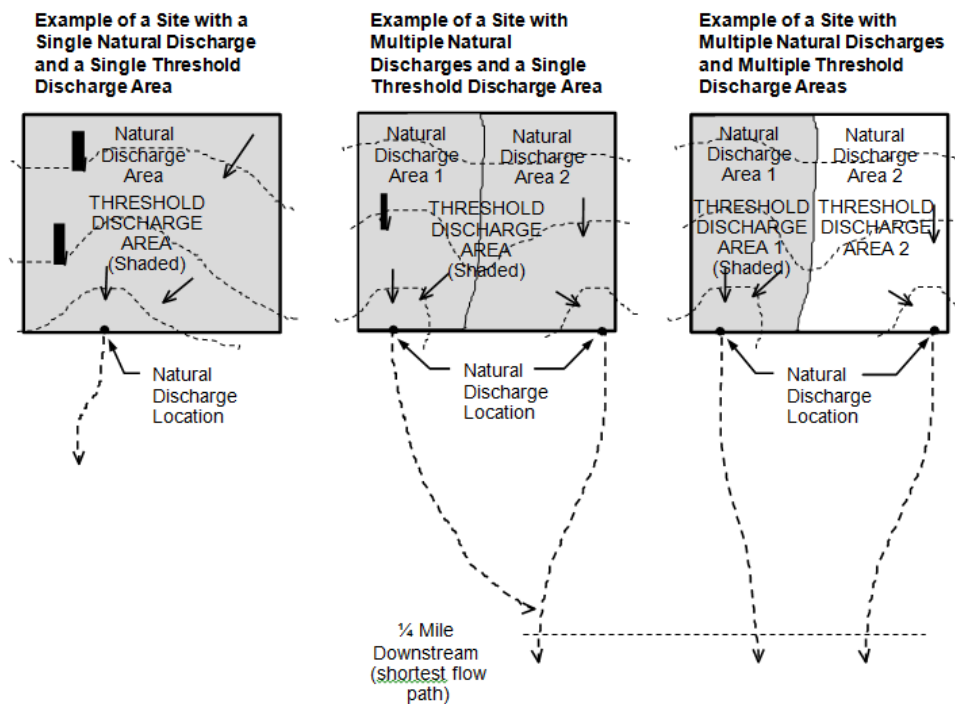

Transportation redevelopment project: a stand-alone transportation improvement project that proposes to add, replace, or modify impervious surface, for purposes other than maintenance, within a length of dedicated public or private road right-of-way that has an existing impervious surface coverage of thirty-five percent or more. Road right-of-way improvements required as part of a subdivision, commercial, industrial or multifamily project may not be defined as a separate transportation redevelopment project.

Treatment Chain: A combination of two or more treatment Best Management Practices connected in series (i.e., the design water volume passes through each facility in turn).

Unsubmerged portion: Any portion outside the ordinary high water line of streams, lakes, and wetlands.

Wetlands: All areas in the city of Kent that are inundated or saturated by surface or groundwater at a frequency and duration sufficient to support, and that under normal circumstances do support, a prevalence of vegetation typically adapted for life in saturated soil conditions. Wetlands generally include swamps, marshes, and similar areas. Wetlands do not include those artificial wetlands intentionally created from nonwetland

sites, including, but not limited to, irrigation and drainage ditches, grass-lined swales, canals, detention facilities, wastewater treatment facilities farm ponds, and landscape amenities. The burden of proving an area to be nonwetland rests with the applicant. Wetlands include artificial wetlands intentionally created from nonwetland areas for the purpose of mitigating conversion of wetlands. The City relies on the methodology contained in the *Wetlands Delineation Manual*, U.S. Army Corps of Engineers Technical Report Y-87-1 for identifying and delineating wetlands within the city. Wetland classes are based on the classification system described in the U.S. Fish and Wildlife Service's *Classification of Wetlands and Deepwater Habitats of the United States* (Cowardin et al. 1979) (See Kent City Code Chapter 11.05).

Wetland Buffer or wetland buffer zone: An area that surrounds and protects a wetland from adverse impacts to the functions and values of a wetland (See Kent City Code Chapter 11).

CHAPTER 1

DRAINAGE REVIEW AND REQUIREMENTS



CITY OF KENT

Surface Water Design Manual

2022

CHAPTER 1

Drainage Review and Requirements	1-1
1.1 Drainage Review	1-1
1.1.1 Projects Requiring Drainage Review	1-3
1.1.2 Drainage Review Types and Requirements	1-4
1.1.3 Drainage Design Beyond Minimum Compliance	1-11
1.2 Core Requirements	1-13
1.2.1 Core Requirement #1: Discharge at The Natural Location.....	1-13
1.2.2 Core Requirement #2: Offsite Analysis	1-14
1.2.3 Core Requirement #3: Flow Control Facilities	1-25
1.2.4 Core Requirement #4: Conveyance System.....	1-39
1.2.5 Core Requirement #5: Erosion and Sediment Control.....	1-43
1.2.6 Core Requirement #6: Maintenance and Operations	1-49
1.2.7 Core Requirement #7: Financial Guarantees and Liability	1-51
1.2.8 Core Requirement #8: Water Quality	1-52
1.2.9 Core Requirement #9: Flow Control BMPs.....	1-61
1.3 Special Requirements	1-76
1.3.1 Special Requirement #1: Other Adopted Area-Specific Requirements	1-76
1.3.2 Special Requirement #2: Flood Hazard Area Delineation.....	1-77
1.3.3 Special Requirement #3: Flood Protection Facilities	1-79
1.3.4 Special Requirement #4: Source Controls	1-80
1.3.5 Special Requirement #5: Oil Control.....	1-82
1.4 Adjustment Process	1-84
1.4.1 Adjustment Authority	1-84
1.4.2 Criteria for Granting Adjustments	1-85
1.4.3 Adjustment Application Process.....	1-87
1.4.4 Adjustment Review Process	1-87

1.4.5 Request For Reconsideration Procedure 1-89

1 DRAINAGE REVIEW AND REQUIREMENTS

A completely revised Chapter 1 is provided below. It is to be used instead of Chapter 1 of the 2016 King County Surface Water Design Manual for all proposals in the city of Kent.

This chapter describes the drainage review procedures and types, the drainage requirements, and the adjustment procedures necessary to implement surface water runoff policies codified in Chapters 7.05 and 7.06 of the Kent City Code. It also provides direction for implementing more detailed procedures and design criteria found in subsequent chapters of this manual.

Chapter Organization

The information presented in Chapter 1 is organized into four main sections as follows:

- Section 1.1, “Drainage Review”
- Section 1.2, “Core Requirements”
- Section 1.3, “Special Requirements”
- Section 1.4, “Adjustment Process”

Formatting of Chapter Text

The text of Chapter 1 and subsequent chapters has been formatted using the following conventions to aid the user in finding, understanding, and properly applying the thresholds, requirements, and procedures contained in this manual:

- *Italic* is used to highlight the following: (a) terms when they are first introduced and defined within the same paragraph; (b) special notes that supplement or clarify thresholds, requirements, and procedures; (c) sentences considered important for purposes of understanding thresholds, requirements, and procedures; and (d) titles of publications.
- ***Bold italic*** is used to highlight terms considered key to understanding and applying drainage review thresholds, requirements, and procedures. These are called "key terms" and are defined below. This convention applies after the key term is defined and does not necessarily apply to tables and figures.
- **Bold** is used to highlight words and phrases that are not key terms but are considered important to emphasize for purposes of finding and properly applying thresholds, requirements, and procedures.

1.1 DRAINAGE REVIEW

Drainage review is the evaluation by city review staff of a proposed project's compliance with the drainage requirements of this manual. During drainage review, city review staff may also consider the proposed project's compliance with other Kent requirements (which are not covered in this manual), such as those specified in the Kent Wetland Management Code, Kent Geologic Hazard Areas Code, and other environmental plans and policies. If required, drainage review becomes an integral part of the overall permit review process. **This section describes when and what type of drainage review is required for a proposed project and how to determine the drainage requirements that apply.**

Guide to Using Section 1.1

The following steps are recommended for efficient use of Section 1.1:

1. Determine whether your proposed project is subject to the requirements of this manual by seeing if it meets any of the thresholds for drainage review specified in Section 1.1.1. Making this determination requires an understanding of the key definitions listed below.
2. If drainage review is required per Section 1.1.1, use the flow chart in Figure 1.1.2.A to determine what type of drainage review will be conducted by city review staff. The type of drainage review defines the scope of drainage requirements that will apply to your project as summarized in Figure 1.1.2.A.
3. Check the more detailed threshold information in Section 1.1.2 to verify that you have determined the correct type of drainage review.
4. After verifying drainage review type, use the information in Section 1.1.2 to determine the core requirements (found in Section 1.2) and the special requirements (found in Section 1.3) that must be evaluated for compliance by your project. To determine what actions are necessary to comply with each applicable core and special requirement, see the more detailed information on these requirements contained in Sections 1.2 and 1.3 of this chapter.

Note: For Steps 2 through 4, it is recommended that you arrange a preapplication meeting with city review staff to confirm the type of drainage review and scope of drainage requirements that apply to your proposed project.

1.1.1 PROJECTS REQUIRING DRAINAGE REVIEW

Drainage review is required for any proposed project (except those proposing only routine maintenance, repair, or emergency modifications) that is subject to a Kent development proposal, permit, or approval listed below, AND that meets any one of the following conditions:

- T
H
R
E
S
H
O
L
D
1. The project adds or will result in 2,000 square feet⁵ or more of new impervious surface, replaced impervious surface, or new plus replaced impervious surface, OR
 2. Proposes to construct or modify a drainage pipe/ditch that is 12 inches or more in size/depth, or receives surface water or stormwater runoff from a drainage pipe/ditch that is 12 inches or more in size/depth, OR
 3. Contains or is adjacent to a flood hazard area, stream, lake, wetland, closed depression, erosion hazard area or landslide hazard area, OR
 4. Is located within a Landslide Hazard Drainage Area, OR
 5. Is a redevelopment project proposing \$100,000⁶ or more of improvements to an existing high-use site, OR
 6. The project proposes 7,000 square feet or more of land disturbing activity.

If drainage review is required for the proposed project, the type of drainage review must be determined based on project and site characteristics as described in Section 1.1.2. The type of drainage review defines the scope of drainage requirements that must be evaluated for project compliance with this manual.

⁵ The thresholds for *new impervious surface*, *replaced impervious surface*, and *land disturbing activity* shall be applied by *project site* and in accordance with the definitions of these surfaces and activities.

⁶ This is the “Total Cost Estimate” as declared on the permit application submitted to the City of Kent or a valuation as determined by the Engineer’s Cost Estimate from the 2021 Kent Design and Construction Standards.

Kent Permits and Approvals

Construction Permits
 Conditional Use Permits
 Grade and Fill Permits
 Flood Control Zone Permit
 Planned Unit Developments
 Rezones
 Shoreline Management Substantial Development Permits
 Short Subdivision Developments
 (Short Plat)
 Subdivision Developments (Plat)

1.1.2 DRAINAGE REVIEW TYPES AND REQUIREMENTS

For most projects adding 2,000 square feet or more of *new* plus *replaced impervious surface*, the full range of core and special requirements contained in Sections 1.2 and 1.3 must be evaluated for compliance through the drainage review process. However, for some types of projects the scope of requirements applied is narrowed to allow more efficient, customized review. Each of the following three drainage review types tailors the review process and application of drainage requirements to a project's size, location, type of development, and anticipated impacts to the local and regional surface water system:

- Simplified Site Drainage Review, Section 1.1.2.1.
- Targeted Drainage Review, Section 1.1.2.2.
- Full Drainage Review, Section 1.1.2.3.

Each project requires only one of the above drainage review types, with the single exception that a project that qualifies for Simplified Site Drainage Review may also require Targeted Drainage Review. Figure 1.1.2.A can be used to determine the drainage review type that would be required. This may entail consulting the more detailed thresholds for each review type specified in the above-referenced sections.

Table 1.1.2.A can be used to quickly identify the requirements that are applied under each type of drainage review. The applicant must evaluate those requirements that are checked off for a particular drainage review type to determine what is necessary to meet compliance.

FIGURE 1.1.2.A FLOW CHART FOR DETERMINING TYPE OF DRAINAGE REVIEW REQUIRED

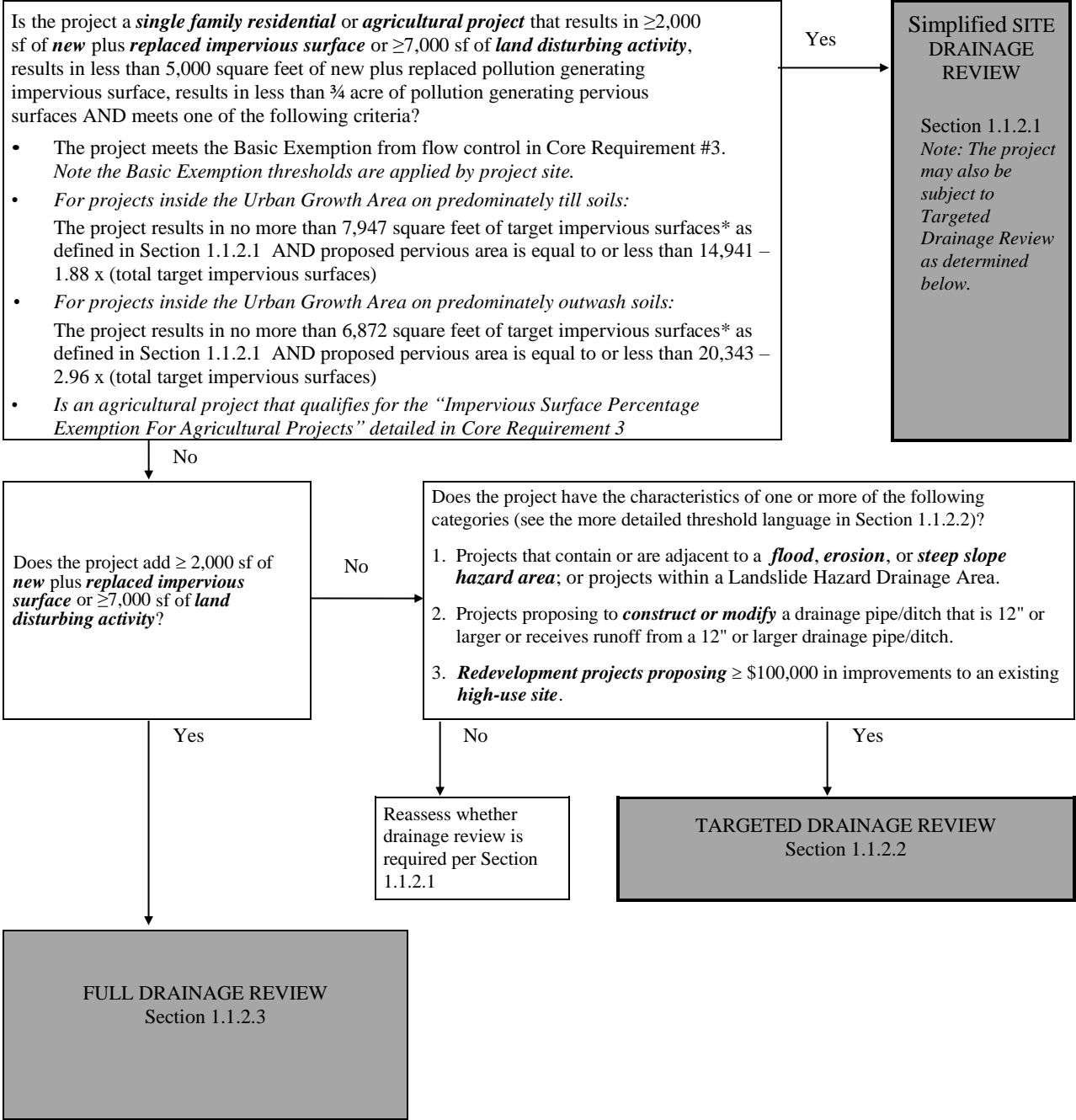

TABLE 1.1.2.A REQUIREMENTS APPLIED UNDER EACH DRAINAGE REVIEW TYPE

	DRAINAGE REVIEW TYPE				
	Simplified	Targeted			Full
		Category 1	Category 2	Category 3	
Simplified	<i>Single-family residential projects that result in $\geq 2,000$ sf of new plus replaced impervious surface or $\geq 7,000$ sf of land disturbing activity but do not exceed the new plus replaced PGIS, new PGPS, and new pervious surface thresholds specified in Sec. 1.1.2.1.</i>				
Targeted	Simplified Site projects or other small projects that are not subject to Full Drainage Review as determined in Section 1.1.2.3, AND which have the characteristics of one or more of the following categories of projects: 1. Projects containing or adjacent to a <i>flood, erosion, or steep slope hazard area</i> ; projects within a Landslide Hazard Drainage Area. 2. Projects proposing to <i>construct or modify</i> a drainage pipe/ditch that is 12" or larger or receives runoff from a 12" or larger drainage pipe/ditch. 3. Redevelopment projects proposing $\geq \$100,000$ in improvements to a <i>high-use site</i> . ⁽¹⁾				
Full	All projects that result in $\geq 2,000$ sf of <i>new plus replaced impervious surface</i> or $\geq 7,000$ sf of <i>land disturbing activity</i> but are not subject to Simplified Site Drainage Review.				
SIMPLIFIED SITE REQUIREMENTS	✓				
CORE REQUIREMENT #1 Discharge at Natural Location	✓ ⁽⁴⁾	* ⁽²⁾	✓		✓
CORE REQUIREMENT #2 Offsite Analysis	✓ ⁽⁴⁾	* ⁽²⁾	✓ ⁽³⁾		✓ ⁽³⁾
CORE REQUIREMENT #3 Flow Control	✓ ⁽⁴⁾	* ⁽²⁾			✓ ⁽³⁾
CORE REQUIREMENT #4 Conveyance System	✓ ⁽⁴⁾	* ⁽²⁾	✓		✓
CORE REQUIREMENT #5 Erosion & Sediment Control	✓ ⁽⁴⁾	✓	✓	✓	✓
CORE REQUIREMENT #6 Maintenance & Operations	✓ ⁽⁴⁾	* ⁽²⁾	✓	✓	✓
CORE REQUIREMENT #7 Financial Guarantees & Liability	✓ ⁽⁴⁾	* ⁽²⁾	✓ ⁽³⁾	✓ ⁽³⁾	✓ ⁽³⁾
CORE REQUIREMENT #8 Water Quality	✓ ⁽⁴⁾	* ⁽²⁾			✓ ⁽³⁾
CORE REQUIREMENT #9 Flow Control BMP's	✓ ⁽⁴⁾				✓
SPECIAL REQUIREMENT #1 Other Adopted Requirements	✓ ⁽⁴⁾	✓ ⁽³⁾			✓ ⁽³⁾
SPECIAL REQUIREMENT #2 Developments within Floodplain/Floodway	✓ ⁽⁴⁾	✓ ⁽³⁾			✓ ⁽³⁾
SPECIAL REQUIREMENT #3 Flood Protection Facilities	✓ ⁽⁴⁾	✓ ⁽³⁾	✓ ⁽³⁾		✓ ⁽³⁾
SPECIAL REQUIREMENT #4 Source Control	✓ ⁽⁴⁾	✓ ⁽³⁾	✓ ⁽³⁾	✓ ⁽³⁾	✓ ⁽³⁾
SPECIAL REQUIREMENT #5 Oil Control	✓ ⁽⁴⁾			✓ ⁽³⁾	✓ ⁽³⁾
(1) Category 3 projects installing oil controls that construct or modify a 12-inch pipe/ditch are also Category 2 projects. (2) May be applied by city review staff based on project or <i>site</i> -specific conditions. Documentation of compliance required. (3) These requirements have exemptions or thresholds that may preclude or limit their application to a specific project. (4) A proposed project subject to Simplified Drainage Review that complies with the Simplified drainage requirements detailed in Appendix C is presumed to comply with all the core and special requirements in Sections 1.2 and 1.3 except those requirements that would apply to the project if it is subject to Targeted Drainage Review as specified in Section 1.1.2.2.					

1.1.2.1 SIMPLIFIED SITE DRAINAGE REVIEW

Simplified Site Drainage Review is a simplified alternative to Full Drainage Review for small residential projects, clearing projects or small *agricultural projects* that meet the threshold requirements below. The core and special requirements applied under Full Drainage Review are replaced with simplified site requirements that can be applied by a non-engineer. These requirements include flow control Best Management Practices (BMPs) such as setting aside open space to limit future site clearing, and using simple measures such as splash blocks and gravel trenches to disperse or infiltrate runoff from impervious areas. Also included are simple BMPs for erosion and sediment control (ESC). Formal water quality treatment is not necessary. This alternative to Full Drainage Review acknowledges that drainage impacts for many small development proposals can be effectively mitigated without construction of costly flow control and water quality facilities.

The Simplified Site Drainage Review process minimizes the time and effort required to design, submit, review, and approve drainage facilities for these proposals. In most cases, the requirements can be met with submittals prepared by contractors, architects, or homeowners without the involvement of a licensed civil engineer.

Threshold

Simplified Site Drainage Review is allowed for any project that is subject to drainage review as determined in Section 1.1.1 and that meets all of the following criteria:

- The project is a *single-family residential project*, AND
- The project will result in 2,000 square feet⁷ or more of *new impervious surface, replaced impervious surface, or new plus replaced impervious surface*, or
- The project will result in 7,000 square feet⁷ or more of *land disturbing activity*,

AND that meets the following criteria:

The project will result in less than 5,000 square feet of new plus replaced pollution generating impervious surface, will result in less than $\frac{3}{4}$ acre of new pollution generating pervious surfaces, AND meets one of the following four additional criteria:

1. **The project meets the Basic Exemption from flow control in Core Requirement #3.** *Note the Basic Exemption thresholds are applied by project site.*
2. **For projects inside the Urban Growth Area on predominately till soils:**
The project results in no more than 7,947 square feet of target impervious surfaces as defined below AND proposed pervious area is equal to or less than $14,941 - 1.88x$ (total target impervious surfaces).
3. **For projects inside the Urban Growth Area on predominately outwash soils:**
The project results in no more than 6,872 square feet of target impervious surfaces as defined below AND proposed pervious area is equal to or less than $20,343 - 2.96x$ (total target impervious surfaces).
4. **For Agricultural Projects:**

⁷ The thresholds of 2,000 and 7,000 square feet shall be applied by project site. All other thresholds specified in terms of square feet of impervious or pervious surface shall be applied by *threshold discharge area* and in accordance with the definitions of these surfaces in Section 1.1. *Note: the calculation of total impervious surface added on after January 8, 2001 may exclude any such added impervious surface that is confirmed by Planning and Economic Development engineering staff to be already mitigated by a County approved and inspected flow control facility or BMP.*

The project is an agricultural project that qualifies for “Impervious Surface Percentage Exemption For Agricultural Projects” as cited in Core Requirement 3 (Flow Control Facilities).

Note: Some projects qualifying for Simplified Site Drainage Review may also require Targeted Drainage Review if they meet any of the threshold criteria in Section 1.1.2.2.

Any potential Simplified site proposal may elect to go through Full Drainage Review described in Section 1.1.2.3.

R E Q U I R E M E N T S

Scope of Requirements

IF Simplified Site Drainage Review is allowed, THEN the applicant may apply the simplified site submittal and drainage design requirements detailed in *Simplified Drainage Requirements* adopted as Appendix C. These requirements include simplified BMPs for flow control and erosion and sediment control. *Note: An open space tract or covenant may be required to preserve uncleared areas.*

Exemption from Core and Special Requirements

The simplified drainage requirements applied under Simplified Site Drainage Review are considered sufficient to meet the overall intent of the core and special requirements in Sections 1.2 and 1.3, except under certain conditions when a proposed project has characteristics that trigger Targeted Drainage Review (see the threshold for Targeted Drainage Review in Section 1.1.2.2) and may require the involvement of a licensed civil engineer. Therefore, any proposed project that qualifies for Simplified Site Drainage Review as determined above and complies with the simplified site drainage requirements detailed in Appendix C is considered exempt from all core and special requirements in Sections 1.2 and 1.3 **except** those which would apply to the project if it is subject to Targeted Drainage Review as specified in Section 1.1.2.2.

1.1.2.2 TARGETED DRAINAGE REVIEW

Targeted Drainage Review (TDR) is an abbreviated evaluation by city review staff of a proposed project's compliance with selected core and special requirements. Projects subject to this type of drainage review are typically small-site proposals or other small projects that have site-specific or project-specific drainage concerns that must be addressed by a licensed ***civil engineer***. Under Targeted Drainage Review, engineering costs associated with drainage design and review are kept to a minimum because the review includes only those requirements that would apply to the particular project.

Threshold

Targeted Drainage Review is required for those projects subject to drainage review as determined in Section 1.1.1, AND that are not subject to Full Drainage Review as determined in Section 1.1.2.3, AND that have the characteristics of one or more of the following project categories:

- **TDR Project Category #1:** Projects that contain or are adjacent to a ***flood hazard area, erosion hazard area, or steep slope hazard area*** as defined in KCC 11.06; OR projects located within a ***Landslide Hazard Drainage Area***.
- **TDR Project Category #2:** Projects that propose to ***construct or modify*** a drainage pipe/ditch that is 12 inches or more in size/depth or receives surface and stormwater runoff from a drainage pipe/ditch that is 12 inches or more in size/depth.
- **TDR Project Category #3:** ***Redevelopment projects*** that propose \$100,000 or more of improvements to an existing ***high-use site***.

Scope of Requirements

R
E
Q IF Targeted Drainage Review is required, THEN the applicant must demonstrate that the proposed project complies with the selected core and special requirements corresponding to the project category or categories that best match the proposed project. The project categories and applicable requirements for each are described below and summarized in Table 1.1.2.A.

Note: If the proposed project has the characteristics of more than one project category, the requirements of each applicable category shall apply.

Compliance with these requirements requires submittal of engineering plans and/or calculations stamped by a licensed **civil engineer** registered in the state of Washington, unless deemed unnecessary by city review staff. The engineer need only demonstrate compliance with those core and special requirements that have been predetermined to be applicable based on specific project characteristics as detailed below and summarized in Table 1.1.2.A. The procedures and requirements for submittal of engineering plans and calculations can be found in Section 2.3.

In addition, **city review staff may require** the applicant to demonstrate compliance with any one or more of the **nine core requirements** in Section 1.2 based on project or site-specific conditions. For example, if a Category #1 TDR Project contains or is adjacent to a **flood hazard area, erosion hazard area, or steep slope hazard area**, OR located within a **Landslide Hazard Drainage Area** city review staff may require compliance with “Core Requirement #1: Discharge at the Natural Location” (Section 1.2.1). This may in turn require compliance with “Core Requirement #2: Offsite Analysis” (Section 1.2.2) if a tightline is required by Core Requirement #1. If a tightline is found to be unfeasible, city review staff may instead require a flow control facility per “Core Requirement #3: Flow Control” (Section 1.2.3). If a tightline is feasible, “Core Requirement #4: Conveyance System” (Section 1.2.4) would be required to ensure proper size and design. Any required flow control facility or tightline system may also trigger compliance with “Core Requirement #6: Maintenance and Operations” (Section 1.2.6), “Core Requirement #7: Financial Guarantees and Liability” (Section 1.2.7), and possibly “Core Requirement #8, Water Quality” (Section 1.2.8) if runoff from pollution-generating impervious surfaces is collected.

The applicant may also have to address compliance with any applicable requirements in the Kent City Code for **flood hazard area, erosion hazard area, or steep slope hazard area**, OR projects located within a **Landslide Hazard Drainage Area** as determined by city review staff.

TDR Project Category #1

This category includes projects that are too small to trigger application of most core requirements, but may be subject to site-specific requirements pertaining to floodplains, streams, lakes, wetlands, closed depressions, Landslide Hazard Drainage Areas, Erosion Hazard Areas, or other area-specific drainage requirements adopted by the City. Such projects primarily include **single-family residential projects** in Simplified Site Drainage Review.

R
E
Q
M
T
S IF the proposed project meets the characteristics of TDR Project Category #1, THEN the applicant must demonstrate that the project complies with the following six requirements:

- Core Requirement #2: Offsite Analysis, Section 1.2.2
- Core Requirement #5: Erosion and Sediment Control, Section 1.2.5
- Special Requirement #1: Other Adopted Area-Specific Requirements, Section 1.3.1
- Special Requirement #2: Floodplain/Floodway Delineation, Section 1.3.2
- Special Requirement #3: Flood Protection Facilities, Section 1.3.3
- Special Requirement #4: Source Control, Section 1.3.4

TDR Project Category #2

This category is intended to apply selected core and special requirements to those projects that propose to **construct or modify** a drainage system of specified size, but are not adding sufficient impervious surface to trigger Full Drainage Review.

IF the proposed project meets the characteristics of TDR Project Category #2, THEN the applicant must demonstrate that the proposed project complies with the following requirements:

- R
E
Q
U
I
R
E
M
E
N
T
- Core Requirement #1: Discharge at the Natural Location, Section 1.2.1
 - Core Requirement #2: Offsite Analysis, Section 1.2.2
 - Core Requirement #4: Conveyance System, Section 1.2.4
 - Core Requirement #5: Erosion and Sediment Control, Section 1.2.5
 - Core Requirement #6: Maintenance and Operations, Section 1.2.6
 - Core Requirement #7: Financial Guarantees and Liability, Section 1.2.7
 - Special Requirement #4: Source Control, Section 1.3.4

TDR Project Category #3

This category is intended to improve water quality by applying water quality, source control, and oil control requirements to **redevelopment projects** located on the most intensively used **sites** developed prior to current water quality requirements. These are referred to as **high-use sites** and are defined below.

IF the proposed project meets the characteristics of TDR Project Category #3, THEN the applicant must demonstrate that the proposed project complies with the following requirements:

- R
E
Q
U
I
R
E
M
E
N
T
S
- Core Requirement #1: Discharge at Natural Location, Section 1.2.1
 - Core Requirement #5: Erosion and Sediment Control, Section 1.2.5
 - Core Requirement #6: Maintenance and Operations, Section 1.2.6
 - Core Requirement #7: Financial Guarantees and Liability, Section 1.2.7
 - Core Requirement #8: Water Quality, Section 1.2.8
 - Special Requirement #4: Source Control, Section 1.3.4
 - Special Requirement #5: Oil Control, Section 1.3.5

Note: In some cases, city review staff may determine that application of these requirements does not require submittal of engineering plans and calculations stamped by a licensed civil engineer. For example, if catch basin inserts are proposed to meet oil control requirements, engineered plans and calculations may not be necessary. A plot plan showing catch basin locations may suffice.

1.1.2.3 FULL DRAINAGE REVIEW

Full Drainage Review is the evaluation by city review staff of a proposed project's compliance with the full range of core and special requirements in this chapter. This review addresses the impacts associated with adding new impervious surface and changing land cover on typical **sites**.

T
H
R
E
S
H
O
L
D

Threshold

Full Drainage Review is required for any proposed new and **redevelopment projects** that are subject to drainage review as determined in Section 1.1.1, AND which meet one or more of the following criteria:

T
H
R
E
S
H

- Projects which will result in 2,000 square feet⁸ or more of ***new impervious surface***, or ***new plus replaced impervious surface*** but which do not qualify for Simplified Site Drainage Review as specified in Section 1.1.2.1, OR
- 7,000 square feet⁸ or more of ***land disturbing activity***, but which do not qualify for Simplified Site Drainage Review as specified in Section 1.1.2.1, OR
- Projects located within a ***Landslide Hazard Drainage Area*** which add 2,000 square feet or more of new impervious surface but which do not qualify for Simplified Site Drainage Review per Section 1.1.2.1, OR
- **Redevelopment projects** proposing \$500,000 or more of site improvements which create 5,000 square feet or more of ***contiguous pollution-generating impervious surface*** through any combination of new and/or ***replaced impervious surface***.

Scope of Requirements

R
E
Q

IF Full Drainage Review is required, THEN the applicant must demonstrate that the proposed project complies with the following requirements:

- All nine core requirements in Section 1.2
- All five special requirements in Section 1.3

Engineering plans and calculations stamped by a licensed ***civil engineer*** registered in the state of Washington must be submitted to demonstrate compliance with these requirements. The procedures and requirements for submittal of engineering plans and calculations are as directed by Economic and Community Development in the Drainage Review Process.

Drainage review for a proposed project’s impact on surface and storm waters may be addressed by processes or requirements apart from Kent’s. Agencies such as those listed below may require some form of drainage review and impose drainage requirements that are separate from and in addition to Kent’s drainage requirements. The applicant is responsible for coordinating with these agencies and resolving any conflicts in drainage requirements.

Agency	Permit/Approval
Seattle/King County Department of Public Health	Onsite Sewage Disposal and Well permits
Washington State	
Department of Transportation	Developer/Local Agency Agreement
Department of Fish and Wildlife	Hydraulic Project Approval
Department of Ecology	Short Term Water Quality Modification Approval
	Dam Safety permit
	NPDES Stormwater permit
	UIC Well Registration
Department of Natural Resources	Forest Practices Class IV permit
United States Army Corps of Engineers	Sections 10, 401, and 404 permits

⁸ The thresholds of 2,000, 5,000, and 7,000 square feet shall be applied by ***project site***.

1.1.3 DRAINAGE DESIGN BEYOND MINIMUM COMPLIANCE

This manual presents Kent's minimum standards for engineering and design of drainage facilities. While the City believes these standards are appropriate for a wide range of development proposals, compliance solely with these requirements does not relieve the professional engineer submitting designs of his or her responsibility to ensure drainage facilities are engineered to provide adequate protection for natural resources and public and private property.

Compliance with the standards in this manual does not necessarily mitigate all probable and significant environmental impacts to aquatic biota. Fishery resources and other living components of aquatic systems are affected by a complex set of factors. While employing a specific flow control standard may prevent stream channel erosion or instability, other factors affecting fish and other biotic resources (such as increases in stream flow velocities) are not directly addressed by this manual. Likewise, some wetlands, including bogs, are adapted to a very constant hydrological regime. Even the most stringent flow control standard employed by this manual does not prevent increases in runoff volume that can adversely affect wetland plant communities by increasing the duration and magnitude of water level fluctuations. Thus, compliance with this manual should not be construed as mitigating all probable and significant stormwater impacts to aquatic biota in streams and wetlands, and additional mitigation may be required.

In addition, the requirements in this manual primarily target the types of impacts associated with the most typical land development projects occurring in the City. Applying these requirements to vastly different types of projects, such as rock quarries or dairy farms may result in poorer mitigation of impacts. Therefore, different mitigation may be required.

Additional mitigation may also be required to compensate for loss of critical area habitat functions associated with reducing standard buffer widths and clearing restrictions as allowed through the approval of Rural Stewardship Plans and Farm Management Plans per KCC 11.06.

1.2 CORE REQUIREMENTS

This section details the following eight core requirements:

- Core Requirement #1: Discharge at the Natural Location, Section 1.2.1
- Core Requirement #2: Offsite Analysis, Section 1.2.2
- Core Requirement #3: Flow Control, Section 1.2.3
- Core Requirement #4: Conveyance System, Section 1.2.4
- Core Requirement #5: Erosion and Sediment Control, Section 1.2.5
- Core Requirement #6: Maintenance and Operations, Section 1.2.6
- Core Requirement #7: Financial Guarantees and Liability, Section 1.2.7
- Core Requirement #8: Water Quality, Section 1.2.8
- Core Requirement #9: Flow Control BMPs, Section 1.2.9

1.2.1 CORE REQUIREMENT #1: DISCHARGE AT THE NATURAL LOCATION

R
E
Q

All surface and stormwater runoff from a project must be discharged at the natural location so as not to be diverted onto or away from downstream properties. The manner in which stormwater runoff and surface water are discharged from **the project site** must not create a significant adverse impact to downhill properties or **drainage facilities** (see “Discharge Requirements” below)

*Note: Projects that do not discharge all **project site** runoff at the natural location will require an approved adjustment of this requirement (see Section 1.4). City review staff may waive this adjustment, however, for projects in which only a small portion of the **project site** does not discharge runoff at the natural location and the runoff from that portion is unconcentrated and poses no significant adverse impact to downstream properties.*

Intent: To prevent adverse impacts to downstream properties caused by diversion of flow from one flow path to another, and to discharge in a manner that does not significantly impact downhill properties or drainage systems. Diversions can cause greater impacts (due to greater runoff volumes) than would otherwise occur from new development discharging runoff at the natural location. Diversions can also impact properties that rely on runoff water to replenish wells and ornamental or fish ponds. *Projects that do not discharge at the natural location will require an approved adjustment of this requirement (see Section 1.4).*

□ DISCHARGE REQUIREMENTS

Proposed projects must comply with the following discharge requirements (1, 2, and 3) as applicable:

1. Where no conveyance system exists at the abutting downstream property line and the natural (existing) discharge is unconcentrated, any runoff concentrated by the proposed project must be discharged as follows:

- a) IF the 100-year peak discharge⁹ is less than or equal to 0.2 cfs under existing conditions and will remain less than or equal to 0.2 cfs under developed conditions, THEN the concentrated runoff may be discharged onto a rock pad or to any other system that serves to disperse flows.
 - b) IF the 100-year peak discharge is less than or equal to 0.5 cfs under existing conditions and will remain less than or equal to 0.5 cfs under developed conditions, THEN the concentrated runoff may be discharged through a dispersal trench or other dispersal system provided the applicant can demonstrate that there will be no significant adverse impact to downhill properties or drainage systems.
 - c) IF the 100-year peak discharge is greater than 0.5 cfs for either existing or developed conditions, or if a significant adverse impact to downhill properties or drainage systems is likely, THEN a conveyance system must be provided to convey the concentrated runoff across the downstream properties to an acceptable discharge point.¹⁰ Drainage easements for this conveyance system must be secured from downstream property owners and recorded prior to engineering plan approval
2. IF a proposed project or any ***natural discharge area*** within a project is located within a ***Landslide Hazard Drainage Area*** and, in fact, ultimately drains over the erodible soils of a defined ***landslide hazard area*** with slopes steeper than 15%, THEN a ***tightline system must be provided*** through the ***landslide hazard area*** to an acceptable discharge point unless one of the following exceptions applies. The tightline system must comply with the design requirements in Core Requirement #4 and in Section 4.2.2 unless otherwise approved by city review staff. Drainage easements for this system must be secured from downstream property owners and recorded prior to engineering plan approval.
- Exceptions:*** A tightline is *not* required for any ***natural discharge location*** where city review staff approves an alternative system based on a geotechnical evaluation/recommendation from a licensed geotechnical engineer that considers cumulative impacts on the hazard area under built out conditions AND one of the following conditions can be met:
- a) Less than 2,000 square feet of ***new impervious surface*** will be added within the ***natural discharge area***, OR
 - b) The developed conditions runoff from the ***natural discharge area*** is less than 0.1 cfs for the 100- year runoff event and will be infiltrated for runoff events up to and including the 100-year event, OR
 - c) The ***developed conditions runoff volume***¹¹ from the ***natural discharge area*** is less than 50% of the existing conditions runoff volume from other areas draining to the location where runoff from the ***natural discharge area*** enters the ***landslide hazard area*** onto slopes steeper than 15%,

⁹ Peak discharges for applying this requirement are determined using the approved runoff model with 15-minute time steps as detailed in Chapter 3.

¹⁰ *Acceptable discharge point* means an enclosed drainage system (i.e., pipe system, culvert, or tightline) or open drainage feature (e.g., ditch, channel, swale, stream, river, pond, lake, or wetland) where concentrated runoff can be discharged without creating a significant adverse impact.

¹¹ For the purposes of applying this exception, the *developed conditions runoff volume* is the average annual runoff volume as computed per Chapter 3. The analysis is performed using the entire period of record. The total volume is divided by the number of full water years being analyzed to determine the annual average runoff volume. Any areas assumed not to be cleared when computing the developed conditions runoff volume must be set aside in an open space tract or covenant in order for the proposed project to qualify for this exception. Preservation of existing forested areas in *Landslide Hazard Drainage Areas* is encouraged.

AND the provisions of Discharge Requirement 1 are met, OR

1.2.2 CORE REQUIREMENT #2: OFFSITE ANALYSIS

R
E
Q
U
I
R
E
M
E
N
T

Project proponents must submit an offsite analysis report that assesses potential offsite drainage and water quality impacts associated with development of the *project site* and that proposes appropriate mitigation measures for those impacts. The initial permit submittal shall include, at minimum, a **Level 1 downstream analysis** as described in Section 1.2.2.1 below. If impacts are identified, the proposed projects shall meet any applicable problem-specific requirements specified in Section 1.2.2.2 for mitigation of impacts to drainage problems and Section 1.2.2.3 for mitigation of impacts to water quality problems.

Intent: To identify and evaluate offsite flooding, erosion, and water quality problems that may be created or aggravated by the proposed project, and to ensure appropriate measures are provided for preventing creation or aggravation of those problems. In addition, this requirement is intended to ensure appropriate provisions are made, as needed, to mitigate other identified impacts associated with the quantity and quality of surface and storm water runoff from the *project site* (e.g., impacts to the hydrology of a wetland as may be identified by a "critical area report." The primary component of an offsite analysis report is the **downstream analysis**. This examines the drainage system within one-quarter mile downstream of the *project site* or farther as described in Section 1.2.2.1 below. It is intended to identify existing or potential/predictable downstream flooding, erosion, and water quality problems so that appropriate mitigation, as specified in Section 1.2.2.2, and 1.2.2.3, can be provided to prevent aggravation of these problems. A secondary component of the offsite analysis report is an **evaluation of the upstream drainage system** to verify and document that significant flooding and erosion impacts will not occur as a result of the proposed project. The evaluation must extend upstream to a point where any backwater effects created by the project cease.

□ EXEMPTION FROM CORE REQUIREMENT #2

With the exception of:

- Projects that trigger Core Requirement #3 (Flow Control Facilities) which must at minimum perform offsite analysis sufficient to identify and address "Downstream Drainage Problems Requiring Special Attention (Section 1.2.2.1.1), Problem Type 4 (Potential Impacts to Wetland Hydrology problem)," and
- Projects that trigger Core Requirement # 8 (Water Quality Facilities) which must at minimum perform offsite analysis sufficient to identify and address "Downstream Water Quality Problems Requiring Special Attention (Section 1.2.2.1.2),"

A proposed project is exempt from Core Requirement #2 if any one of the following is true:

1. City review staff determines there is sufficient information to conclude that the project will not have a significant adverse impact on the downstream and/or upstream drainage system, OR
2. The project adds less than 2,000 square feet of *new impervious surface*, AND less than $\frac{3}{4}$ acre of *new pervious surface*, AND does not **construct or modify** a drainage pipe/ditch that is 12 inches or more in size/depth or that receives runoff from a drainage pipe/ditch that is 12 inches or more in size/depth, AND does not contain or lie adjacent to a **landslide, steep slope, or erosion hazard area**, OR
3. The project does not change the rate, volume, duration, or location of discharges to and from the *project site* (e.g., where existing impervious surface is replaced with other impervious surface having similar runoff-generating characteristics, or where pipe/ditch modifications do not change existing discharge characteristics).

1.2.2.1 DOWNSTREAM ANALYSIS

The level of downstream analysis required depends on specific *site* and downstream conditions. Each project submittal must include at least a Level 1 downstream analysis. Upon review of the Level 1 analysis, DPER may require a Level 2 or Level 3 analysis. If conditions warrant, additional, more detailed analysis may be required.

The **Level 1 downstream analysis** is a qualitative survey of each downstream system and is the first step in identifying flooding problems, or potential impacts to wetland hydrology problems as described below under “Downstream Drainage Problems Requiring Special Attention.” Each Level 1 analysis is composed of four tasks at a minimum:

- Task 1: Define and map the study area
- Task 2: Review all available information on the study area
- Task 3: Field inspect the study area
- Task 4: Describe the drainage system, and its existing and predicted problems

Upon review of the Level 1 analysis, city review staff may require a Level 2 or 3 downstream analysis, depending on the presence of existing or predicted flooding, erosion, or nuisance problems identified in the Level 1 analysis.

Levels 2 and 3 downstream analyses quantify downstream flooding, erosion, or nuisance problems by providing information on the severity and frequency of an existing problem or the likelihood of creating a new problem. A Level 2 analysis is a rough quantitative analysis (non-survey field data, uniform flow analysis). Level 3 is a more precise analysis (survey field data, backwater analysis) of significant problems. If conditions warrant, additional, more detailed analysis may be required beyond Level 3. For Levels 2 and 3 downstream analyses, an additional **Task 5**, addressing mitigation of existing and potential flooding, erosion, or nuisance problems, will be required.

Extent of Downstream Analysis

The downstream analysis must consider the existing conveyance system(s) for a **minimum flowpath distance downstream** of one-quarter mile and beyond that, as needed, to reach a point where the *project site* area constitutes less than 15% of the tributary area. This minimum distance **may be increased** as follows:

- **Task 2** of a Level 1 downstream analysis (described in detail in Section 2.3.1.1) is a review of all available information on the downstream area and is intended to identify existing drainage and water quality problems. *In all cases, this information review shall extend one mile downstream of the project site.* The existence of flooding or erosion problems further downstream may extend the one-quarter-mile/15% minimum distance for other tasks to allow evaluation of impacts from the proposed development upon the identified flooding or erosion problems. The existence of documented water quality problems beyond the one-quarter-mile/15% distance may in some cases require additional mitigation of impacts as determined necessary by city review staff based on the type and severity of problem.
- If a project's impacts to flooding or erosion problems are mitigated by improvements to the downstream conveyance system, the downstream analysis will extend a minimum of one-quarter mile beyond the improvement. This is necessary because many such improvements result in a reduction of stormwater storage or an increase in peak flows from the problem location.
- At their discretion, city review staff may extend the downstream analysis beyond the minimum distance specified above on the reasonable expectation of drainage or water quality impacts.

A detailed description of offsite analysis scope and submittal requirements is provided in Section 2.3.1.1. Hydrologic analysis methods and requirements for Levels 2 and 3 downstream analysis are contained in Chapter 3; hydraulic analysis methods are contained in Chapter 4.

1.2.2.1.1 DOWNSTREAM PROBLEMS REQUIRING SPECIAL ATTENTION

While the area-specific flow control facility requirement in Core Requirement #3 serves to minimize the creation and aggravation of many types of downstream drainage problems, there are some types that are more sensitive to creation/aggravation than others depending on the nature or severity of the problem and which flow control facility standard is being applied. In particular, there are four types of downstream problems where the City has determined that the nature and/or severity of the problem warrants additional attention through the downstream analysis and possibly additional mitigation to ensure no creation/aggravation:

1. *Conveyance system nuisance problem*
2. *Severe erosion problem*
3. *Severe flooding problem*
4. *Potential Impacts to Wetland Hydrology problem.*

These four types of downstream drainage problems are further described below and precisely defined at the beginning of Chapter 1.

Conveyance System Nuisance Problems (Type 1)

Conveyance system nuisance problems are minor but chronic flooding or erosion problems that result from the overflow of a constructed conveyance system that is substandard or has become too small as a result of *upstream development*. Such problems warrant additional attention because of their chronic nature and because they result from the failure of a conveyance system to provide a minimum acceptable level of protection.

If a *conveyance system nuisance problem* is identified or predicted downstream, the need for additional mitigation must be evaluated as specified in Section 1.2.2.2 under “Drainage Problem-Specific Mitigation Requirements.” This may entail additional onsite flow control or other measures as needed to prevent creation or significant aggravation of the problem.

For any other nuisance problems which may be identified downstream, this manual does not require mitigation beyond the area specific flow control facility requirement applied in Core Requirement #3. This is because preventing aggravation of such problems (e.g., those caused by the elevated water surfaces of ponds, lakes, wetlands, and closed depressions or those involving downstream erosion) can require two to three times as much onsite detention volume, which is considered unwarranted for addressing nuisance problems. However, if under some unusual circumstance, the aggravation of such a problem is determined by city review staff to be a significant adverse impact, additional mitigation may be required.

Severe Erosion Problems (Type 2)

Severe erosion problems can be caused by conveyance system overflows or the concentration of runoff into erosion-sensitive open drainage features. *Severe erosion problems* warrant additional attention because they pose a significant threat either to health and safety or to public or private property.

If a *severe erosion problem* is identified or predicted downstream, additional mitigation must be considered as specified in Section 1.2.2.2 under “Drainage Problem Impact Mitigation Requirements.” This may entail additional onsite flow control or other measures as needed to prevent creation or aggravation of the problem.

Severe Flooding Problems (Type 3)

Severe flooding problems, (i.e., a *severe building flooding problem* or *severe roadway flooding problem*) can be caused by conveyance system overflows or the elevated water surfaces of ponds, lakes, wetlands, or closed depressions. *Severe flooding problems* warrant additional attention because they pose a significant threat either to health and safety or to public or private property.

If a *severe flooding problem* is identified or predicted downstream, the need for additional mitigation must be evaluated as specified in Section 1.2.2.2 under “Drainage Problem Impact Mitigation Requirements.” This may entail consideration of additional onsite flow control or other measures as needed to prevent creation or significant aggravation of the problem.

Potential Impacts to Wetlands Hydrology Problem (Type 4)

Potential impacts to wetlands hydrology can be caused by changes in the rate, duration, and quantity of stormwater discharged from the project site to a wetland.

Where wetlands are identified on the site, the applicant shall submit a critical area report at a level determined by city review staff to adequately evaluate the proposal and probable impacts.

Where wetlands are identified off the site AND the project is not exempt from Core Requirement 3, the applicant shall submit a critical area report at a level determined by city review staff to adequately evaluate the proposal and probable impacts.

Projects or threshold discharge areas within projects discharging to wetlands, unless exempt from providing a flow control facility per Core Requirement 3, must demonstrate that the existing wetland hydroperiod is maintained in accordance with the wetland hydrology protection guidelines in Reference Section 5.

Based upon the critical area report and, if applicable, the analysis of project compliance with the wetland hydrology protection guidelines in Reference Section 5, city review staff will determine if changes in the rate, duration, and/or quantity of surface and storm water runoff from a proposed project or *threshold discharge area* within a proposed project could significantly alter the hydrology of a wetland-- in which case, city review staff will require (as described in Section 1.2.2.2 under “Drainage Problem Impact Mitigation Requirements”), implementation of additional flow control or other measures to mitigate the adverse impacts of this alteration in accordance with the wetland hydrology protection guidelines in Reference Section 5.

1.2.2.1.2 DOWNSTREAM WATER QUALITY PROBLEMS REQUIRING SPECIAL ATTENTION

A *water quality problem*, for the purposes of impact mitigation in this manual, is a situation in which a waterbody of the State is documented by the Federal Government, State, County, or City to be exceeding or at concern of exceeding the State's numeric water quality standards, or is subject to a federal, state, or county cleanup program or action. Water quality problems and associated water quality standards encompass surface water, groundwater, and sediment quality. The goal of this manual is to prevent creation or significant aggravation of such problems to the maximum extent practicable. While the area-specific water quality facility requirement in Section 1.2.8.1, the source controls required in Section 1.3.4, and the oil controls required in Section 1.3.5 all serve to minimize the creation and aggravation of

many types of downstream water quality problems, there are some types that are either not addressed by these requirements (e.g., temperature problems) or warrant additional measures/considerations to minimize the proposed project's impacts to the maximum extent practicable. In particular, there are currently 7 types of downstream water quality problems for which the County has determined that additional attention needs to be given to preventing or minimizing increases in the pollutant or pollutants of concern discharging from the *site*. These are as follows:

1. Bacteria Problem
2. Dissolved Oxygen Problem
3. Temperature Problem
4. Metals Problem
5. Phosphorus Problem
6. Turbidity Problem
7. High pH Problem

These problems are defined below and the mitigation of impacts to them is addressed in Section 1.2.2.3.

Bacteria Problem (Type 1)

A *bacteria problem* is defined as a stream reach, lake, or other waterbody of the state that is either (1) currently **designated by the state as a Category 5, 4, or 2 Waterbody** due to exceedance or concern for exceedance of the state's numeric water quality standard for **fecal coliform** as documented in the state's Water Quality Assessment 303(d)/305(b) Integrated Report and as displayed in WA Ecology's electronic database and map viewer¹² of these waterbodies, or (2) is currently **designated by the City as a bacteria problem** based on credible data indicating exceedance or concern for exceedance of the state's numeric water quality standard for **fecal coliform**.

Dissolved Oxygen (DO) Problem (Type 2)

A *dissolved oxygen problem* is defined as a stream reach, lake, or other waterbody of the state that is either (1) currently **designated by the state as a Category 5, 4, or 2 Waterbody** due to exceedance or concern for exceedance of the state's numeric water quality standard for dissolved oxygen as documented in the state's Water Quality Assessment 303(d)/305(b) Integrated Report and as displayed in WA Ecology's electronic database and map viewer¹² of these waterbodies, or (2) is currently **designated by the City as a DO problem** based on credible data indicating exceedance or concern for exceedance of the state's numeric water quality standard for dissolved oxygen.

Temperature Problem (Type 3)

A *temperature problem* is defined as a stream reach, lake, or other waterbody of the state that is either (1) currently **designated by the state as a Category 5, 4, or 2 Waterbody** due to exceedance or concern for exceedance of the state's numeric water quality standard for temperature as documented in the state's Water Quality Assessment 303(d)/305(b) Integrated Report and as displayed in WA Ecology's electronic database and map viewer¹² of these waterbodies, or (2) is currently **designated by**

¹² The link to the Query Tool is <https://fortress.wa.gov/ecy/wats/approvedsearch.aspx> ; select all appropriate mediums.

The Map Tool is at <https://fortress.wa.gov/ecy/wqamapviewer/default.aspx?res=1280x1024>

the City as a temperature problem based on credible data indicating exceedance or concern for exceedance of the state's numeric water quality standard for temperature.

Metals Problem (Type 4)

A *metals problem* is defined as a stream reach, lake, or other waterbody of the state that is either (1) currently **designated by the state as a Category 5, 4, or 2 Waterbody** due to exceedance or concern for exceedance of the state's numeric water quality standards for metals (**e.g., copper, zinc, lead, mercury, etc.**) as documented in the state's Water Quality Assessment 303(d)/305(b) Integrated Report and as displayed in WA Ecology's electronic database and map viewer¹² of these waterbodies, or (2) is currently **designated by the City as a metals problem** based on credible data indicating exceedance or concern for exceedance of the state's numeric water quality standards for metals (**e.g., copper, zinc, lead, mercury, etc.**), or (3) where subject to any other local, state, or federal cleanup plan or contaminated site designation.

Phosphorus Problem (Type 5)

A *phosphorus problem* is defined as a stream reach, lake, or other waterbody of the state that is either (1) currently **designated by the state as a Category 5, 4, or 2 Waterbody** due to exceedance or concern for exceedance of the state's numeric action standard for **total phosphorus** as documented in the state's Water Quality Assessment 303(d)/305(b) Integrated Report and as displayed in WA Ecology's electronic database and map viewer¹³ of these waterbodies, or (2) is currently **designated by the City as a nutrient problem** based on credible data indicating exceedance or concern for exceedance of the state's numeric action standard for **total phosphorus**.

Turbidity Problem (Type 6)

A *turbidity problem* is defined as a stream reach, lake, or other waterbody of the state that is either (1) currently **designated by the state as a Category 5, 4, or 2 Waterbody** due to exceedance or concern for exceedance of the state's numeric water quality standard for turbidity as documented in the state's Water Quality Assessment 303(d)/305(b) Integrated Report and as displayed in WA Ecology's electronic database and map viewer¹³ of these waterbodies.

High pH Problem (Type 7)

A *High pH problem* is defined as a stream reach, lake, or other waterbody of the state that is either (1) currently **designated by the state as a Category 5, 4, or 2 Waterbody** due to exceedance or concern for exceedance of the state's numeric water quality standard for high pH as documented in the state's Water Quality Assessment 303(d)/305(b) Integrated Report and as displayed in WA Ecology's electronic database and map viewer¹³ of these waterbodies, or (2) is currently **designated by the City as a pH problem** based on credible data indicating exceedance or concern for exceedance of the state's numeric water quality standard for pH.

NOTE: The Washington State Department of Ecology regularly updates its water quality designations. Additional lake, stream, or river reaches may be included on the list without notice. Please refer to the Ecology's Water Quality Assessment and 303(D) List website at: <http://www.ecy.wa.gov/programs/Wq/303d/index.html>

¹³ The link to the Query Tool is <https://fortress.wa.gov/ecy/wats/approvedsearch.aspx> ; select all appropriate mediums.

The Map Tool is at <https://fortress.wa.gov/ecy/wqamapviewer/default.aspx?res=1280x1024>

1.2.2.2 DRAINAGE PROBLEM IMPACT MITIGATION

A proposed project must not significantly aggravate existing downstream problems or create new problems as a result of developing the site. This manual does not require development proposals to fix or otherwise reduce the severity of existing downstream drainage problems, although doing so may be an acceptable mitigation.

❑ PRINCIPLES OF IMPACT MITIGATION FOR DRAINAGE PROBLEMS

Aggravation of an existing downstream problem means increasing the frequency of occurrence and/or severity of the problem. Increasing peak flows at the location of a problem caused by conveyance system overflows can increase the frequency of the problem's occurrence. Increasing durations of flows at or above the overflow return frequency can increase the severity of the problem by increasing the depth and duration of flooding. Controlling peaks and durations through onsite detention can prevent aggravation of such problems by releasing the increased volumes from development at return frequencies below the conveyance overflow return frequency, which limits their effect to just causing the conveyance system to flow full for a longer period of time.

When a problem is caused by high-water surface elevations of a volume-sensitive water body, such as a lake, wetland, or closed depression, aggravation is the same as for problems caused by conveyance overflows. Increasing the volume of flows to a volume-sensitive water body can increase the frequency of the problem's occurrence. Increasing the duration of flows for a range of return frequencies both above and below the problem return frequency can increase the severity of the problem; mitigating these impacts requires control of flow durations for a range of return frequencies both above and below the problem return frequency. The net effect of this duration control is to release the increased volumes due to development only at water surface elevations below that causing the problem, which in turn can cause an increase in these lower, but more frequently occurring, water surface elevations. This underscores an unavoidable impact of development upstream of volume-sensitive water bodies: the increased volumes generated by the development will cause some range of increase in water surface elevations, no matter what detention standard is applied.

Creating a new problem means increasing peak flows and/or volumes such that after development, the frequency of conveyance overflows or water surface elevations exceeds the thresholds for the various problem types discussed in Section 1.2.2.1. For example, application of the Level 1 flow control standard requires matching the *existing site conditions* 2- and 10-year peak flows. The 100-year peak flow is only partially attenuated, and the flow increase may be enough to cause a *severe flooding problem*. The potential for causing a new problem is often identified during the Level 1 downstream analysis, where the observation of a reduction in downstream pipe sizes, for example, may be enough to predict creation of a new problem. A Level 2 or 3 analysis will typically be required to verify the capacity of the system and determine whether 100-year flows can be safely conveyed.

❑ SIGNIFICANCE OF IMPACTS TO EXISTING DRAINAGE PROBLEMS

The determination of whether additional onsite mitigation or other measures are needed to address an existing downstream problem depends on the significance of the proposed project's predicted impact on that problem. For some identified problems, city review staff will make the determination as to whether the project's impact is significant enough to require additional mitigation. For Type 1, 2, and 3 downstream drainage problems described in Section 1.2.2.1.1, this threshold of significant impact or aggravation is defined below. For a Type 4, "*Potential Impacts to Wetland Hydrology problem*," city review staff will make this determination based on required critical area report findings, whether the project is in compliance with the wetland hydrology protection guidelines found in Reference Section 5, the project's relative contribution to the identified wetland's hydrology, and the mitigation proposed in meeting other requirements (e.g. flow control facilities and flow control BMPs).

For **conveyance system nuisance problems**, the problem is considered significantly aggravated if there is any increase in the project's contribution to the frequency of occurrence and/or severity of the problem for runoff events less than or equal to the 10-year event. *Note: Increases in the project's contribution to this type of problem are considered to be prevented if sufficient onsite flow control and/or offsite improvements are provided as specified in Table 1.2.3.A.*

For **severe erosion problems**, the problem is considered significantly aggravated if there is any increase in project's existing contribution to the *flow duration*¹⁴ of peak flows ranging from 50% of the 2-year peak flow up to the full 50-year peak flow at the eroded area. *Note: Increases in the project's contribution to this type of problem are considered to be prevented if Conservation flow control or offsite improvements are provided as specified in Table 1.2.3.A.*

For **severe building flooding problems**, the problem is considered significantly aggravated if there is any increase in the project's existing contribution¹⁵ to the frequency, depth, and/or duration of the problem for runoff events less than or equal to the 100-year event.

For **severe roadway flooding problems**, the problem is considered significantly aggravated if any of the following thresholds are exceeded and there is any increase in the project's contribution¹⁹ to the frequency, depth, and/or duration of the problem for runoff events less than or equal to the 100-year event:

- The *existing flooding*¹⁶ over all lanes of a **roadway** or overtopping the culverted section of a **sole access driveway** is predicted to increase in depth more than a quarter-inch or 10% (whichever is greater) for the 100-year runoff event.
- The existing flooding over all lanes of a **roadway** or severely impacting a **sole access driveway** is more than 6 inches deep or faster than 5 feet per second for runoff events less than or equal to the 100-year event. A **severely impacted sole access driveway** is one in which flooding overtops a culverted section of the driveway, posing a threat of washout or unsafe access conditions due to indiscernible driveway edges, or flooding is deeper than 6 inches on the driveway, posing a severe impediment to emergency access.
- The existing flooding over all lanes of a *sole access roadway*¹⁷ is more than 3 inches deep or faster than 5 feet per second for runoff events less than or equal to the 100-year event, or is at any depth for runoff events less than or equal to the 10-year event.

□ DRAINAGE PROBLEM-SPECIFIC MITIGATION REQUIREMENTS

1. IF a proposed project or **threshold discharge area** within a project drains to one or more of the Type 1, Type 2, or Type 3 downstream drainage problems described in Section 1.2.2.1 as identified through a downstream analysis, THEN the applicant must do one of the following:

¹⁴ *Flow duration* means the aggregate time that peak flows are at or above a particular flow rate of interest (e.g., the amount of time over the last 40 years that peak flows were at or above the 2-year flow rate).

¹⁵ Increases in the project's contribution are considered to be prevented if sufficient onsite flow control and/or offsite improvements are provided as specified for "severe flooding problems" in Table 1.2.3.A.

¹⁶ *Existing flooding*, for the purposes of this definition, means flooding over all lanes of the roadway or driveway has occurred in the past and can be verified by City records, City personnel, photographs, or other physical evidence.

¹⁷ *Sole access roadway* means there is no other flood-free route for emergency access to one or more dwelling units.

- a) Submit a Level 2 or Level 3 downstream analysis per Section 2.3.1 demonstrating that the proposed project will not create or significantly aggravate the identified downstream problem(s),
OR
 - b) Show that the *natural discharge area* or *threshold discharge area* draining to the identified problem(s) qualifies for an exemption from Core Requirement #3: Flow Control (Section 1.2.3) or an exception from the applicable area-specific flow control facility requirement per Section 1.2.3.1
OR
 - c) Document that the applicable area-specific flow control facility requirement specified in Core Requirement #3 is adequate to prevent creation or significant aggravation of the identified downstream drainage problem(s) as indicated in Table 1.2.3.A with the phrase, “No additional flow control needed,” OR
 - d) Provide additional onsite flow control necessary to prevent creation or significant aggravation of the downstream problem(s) as specified in Table 1.2.3.A and further detailed in Section 3.3.5, OR
 - e) Provide offsite improvements necessary to prevent creation or significant aggravation of the identified downstream drainage problem(s) as detailed in Chapter 3 unless identified as not necessary in Table 1.2.3.A, OR
 - f) Provide a combination of additional onsite flow control and offsite improvements sufficient to prevent creation or significant aggravation of the downstream drainage problem(s) as demonstrated by a Level 2 or Level 3 downstream analysis.
2. IF it is identified that the manner of discharge from a proposed project may create a significant adverse impact as described in Core Requirement #1, THEN city review staff may require the applicant to implement additional measures or demonstrate the impact will not occur.
 3. IF it is identified through a critical area review as described under “**Potential Impacts to Wetlands Hydrology Problem (Type 4)**”, that changes in the rate, duration, and/or the quantity of surface and storm water runoff from a proposed project or *threshold discharge area* within a proposed project could significantly alter the hydrology of a wetland (Type 4 problem), THEN city review staff shall require the applicant to implement additional flow control or other measures to mitigate the adverse impacts of this alteration in accordance with the wetland hydrology protection guidelines in Reference Section 5.

Intent: To ensure provisions are made (if necessary) to prevent creation or significant aggravation of the four types of downstream drainage problems requiring special attention by this manual, and to ensure compliance with the discharge requirements of Core Requirement #1.

In addressing downstream problems per Drainage Problem-Specific Mitigation Requirement 1 above, the additional onsite flow control will often be the easiest provision to implement. This involves designing the required onsite flow control facility to meet an additional set of performance criteria targeted to prevent significant aggravation of specific downstream drainage problems. To save time and analysis, a set of predetermined flow control performance criteria corresponding to each of the three types of downstream problems is provided in Table 1.2.3.A and described in more detail in Chapter 3.

Note that in some cases, the area-specific flow control facility requirement applicable to the proposed project per Section 1.2.3.1 is already sufficient to prevent significant aggravation of many of the defined downstream drainage problem types. Such situations are noted in Table 1.2.3.A as not needing additional onsite flow control or offsite improvements. For example, if the project is located within a Conservation Flow Control Area subject to the Level 2 flow control standard per Section 1.2.3.1.B and a *conveyance system nuisance problem* is identified through offsite analysis per Core Requirement #2, no additional onsite flow control is needed, and no offsite improvements are necessary.

1.2.2.3 WATER QUALITY PROBLEM IMPACT MITIGATION

As stated in Section 1.2.2.1, the goal of this manual is to prevent creation and/or significant aggravation of water quality problems to the maximum extent practicable. This is accomplished through a number of mitigation requirements, including (1) the area-specific water quality facility requirement in Section 1.2.8.1, (2) any mitigation required by other adopted area-specific requirements per Special Requirement #1, Section 1.3.1, (3) the source controls required in Special Requirement #4, Section 1.3.4, (4) the oil control required in Special Requirement #5, Section 1.3.5, and (5) the water quality problem-specific mitigation requirements presented in this section. *Note that this manual does not require development proposals to fix or otherwise reduce the severity of existing downstream water quality problems, although doing so may be an acceptable mitigation.*

❑ WATER QUALITY PROBLEM-SPECIFIC MITIGATION REQUIREMENTS

IF a proposed project drains to one or more of the 7 types of downstream water quality problems defined in Section 1.2.2.1 as identified through a downstream analysis, THEN the applicant must comply with the following problem-specific mitigation requirements that apply. *Note that city review staff may require additional measures if the opportunity exists to further mitigate the pollutants of concern associated with these types of problems.*

Bacteria Problem (Type 1)

IF the proposed project drains to a bacteria problem located within the quarter mile/15% distance downstream (or beyond as deemed necessary by city review staff), THEN the following requirements must be met as applicable:

1. IF a water quality facility is required per Core Requirement #8, THEN **filter cartridges** or **stormwater wetland** shall be used to meet the area-specific water quality facility requirement. Cartridge filters are the preferred option. Other treatment options for meeting the area-specific facility requirement may be used in lieu of a filter cartridges or stormwater wetland only if combined with an **emerging technology treatment method** that provides equivalent removal of fecal coliform as demonstrated through an experimental design adjustment per Section 1.4.
2. IF the proposed project is a residential subdivision, THEN **signage** shall be provided in the subdivision's public areas (i.e., recreation/open space areas and right-of-way) requesting that pet waste be picked up in order to protect downstream water quality. The extent and location of this signage shall be reviewed and approved by city review staff.
3. IF the proposed project is a multifamily development with a recreation/open area or is a park improvement, THEN **signage** shall be provided requesting that pet waste be picked up in order to protect downstream water quality. The extent and location of this signage shall be reviewed and approved by city review staff.

Dissolved Oxygen (DO) Problem (Type 2)

IF the proposed project drains to a DO problem located within the quarter mile/15% distance downstream (or beyond as deemed necessary by city review staff), THEN the following requirements must be met as applicable:

1. IF the proposed project includes a wetpond or wetvault, THEN the **wetpool depth** shall not exceed 6 feet, AND the outflow system shall include a measure designed to **promote aeration** of the facility's discharges for 2-year runoff events and smaller. One way to do this is to create a drop in flow elevation within a manhole by placing the outlet invert of the incoming pipe a minimum of 12 inches above the 2-year headwater elevation of the outgoing pipe. Alternatively, if the outflow system discharges to an open channel, the same drop in flow elevation could be achieved by placing the outlet invert a minimum of 12 inches above the 2-year tailwater elevation created by the channel. Other equivalent approaches may be used as approved by city review staff.

2. IF the proposed project includes a wetvault, THEN the required **ventilation area** specified in Chapter 6 shall be doubled.
3. IF the DO problem is documented to be caused by **excessive phosphorus** and a water quality facility is required per Core Requirement #8, THEN a water quality facility option from the **Sensitive Lake Protection menu** shall be a component of the required treatment system.

Temperature Problem (Type 3)

IF the proposed project drains to a temperature problem located within the quarter mile/15% distance downstream (or beyond as deemed necessary by city review staff), THEN the following requirements must be met as applicable:

1. IF a water quality facility is required per Core Requirement #8, THEN use of a **wetpond is prohibited** unless it will be at least 50% shaded at midday in the summer or its discharges will flow through 200 feet or more of open channel that is at least 50% shaded at midday in the summer. City review staff shall review and approve the extent and location of this shading.
2. IF the proposed project includes open drainage features, THEN vegetation or other means shall be used where practicable to **maximize shading** of the drainage features, except bioswales and filter strips. The extent and location of this shading shall be reviewed and approved by city review staff.

Metals Problem (Type 4)

IF the proposed project drains to a metals problem located within the quarter mile/15% distance downstream (or beyond as deemed necessary by city review staff), THEN the following requirements must be met as applicable:

1. IF a water quality facility is required per Core Requirement #8, THEN a water quality facility option from the **Enhanced Basic WQ menu** shall be a component of the project's required treatment system.
2. IF the proposed project is a residential subdivision, THEN a **covenant** shall be recorded for each lot and common area tract prohibiting use of **leachable heavy metals** (e.g., galvanized metals) that will be exposed to the weather (use the covenant in Reference Section 8-Q).
3. IF the proposed project includes road right-of-way improvements, THEN use of **leachable heavy metals** (e.g., galvanized metals) that will be exposed to the weather (e.g., **guard rails, street lights**, etc.) shall be avoided.

Phosphorus Problem (Type 5)

IF the proposed project drains to a phosphorus problem located within the quarter mile/15% distance downstream (or beyond as deemed necessary by city review staff), THEN the following requirements must be met as applicable:

1. IF a water quality facility is required per Core Requirement #8, THEN the project shall be assumed to be located within a designated Sensitive Lake WQ Treatment Area for the purposes of applying the area-specific water quality treatment requirement in Section 1.2.8.1.
2. For the purposes of applying the Erosion and Sediment Control Standards in Appendix D, the project shall be assumed to be located within a designated Sensitive Lake WQ Treatment Area.

Turbidity Problem (Type 6)

IF the proposed project drains to a turbidity problem located within the quarter mile/15% distance downstream (or beyond as deemed necessary by city review staff) AND the downstream flow path from

the *project site* to the turbidity problem is through a landslide hazard area, steep slope hazard area, erosion hazard area or any actively eroding area, THEN the project shall provide a tightline system through the area in accordance with the same criteria and exceptions specified in Core Requirement #1, **Discharge Requirement 2** for projects located within a designated Landslide Hazard Drainage Area. Other means for safely conveying *project site* discharges through the area of concern for erosion may be proposed subject to approval by city review staff.

High pH Problem (Type 7)

IF the proposed project drains to a pH problem located within the quarter mile/15% distance downstream (or beyond as deemed necessary by city review staff) AND the proposed project includes a concrete vault structure for stormwater control purposes, THEN the vault's submerged surfaces shall be coated or otherwise treated to prevent alteration of pH.

1.2.3 CORE REQUIREMENT #3: FLOW CONTROL FACILITIES

R
E
Q All proposed projects, including *redevelopment projects*, must provide onsite flow control facilities to mitigate the impacts of storm and surface water runoff generated by *new impervious surface*, *new pervious surface*, and replaced impervious surface targeted for flow mitigation as specified in the following sections. **Flow control** facilities shall, at a minimum, meet the performance criteria for one of the area-specific flow control standards described in Section 1.2.3.1 and be implemented according to the applicable flow control facility implementation requirements in Section 1.2.3.2.

Intent: To ensure the minimum level of control needed to protect downstream properties and resources from increases in peak, duration, and volume of runoff generated by new development. The level of control varies depending on location and downstream conditions identified under Core Requirement #2.

□ EXEMPTIONS/VARIANCES FROM CORE REQUIREMENT #3

The following are exemptions and variances from the flow control provisions of Core Requirement #3:

Basic Exemption

A proposed project is exempt if it meets the following criteria:

- a) Less than 5,000 square feet of *new* plus *replaced impervious surface* will be created, AND
- b) Less than ¾ acres of *new pervious surface* will be added.

Green River Management Agreement and Detention Requirements

In accordance with the **provisions of the Green River Management Agreement**, if the proposed development is located in an area that has a direct, gravity draining outlet to the Green River or is tributary to such a system (other than via the Black River Pumping Station) then stormwater runoff can be released, after all the following conditions are met:

- 1) Flood storage must be provided that is equivalent to the amount of rainfall falling on the entire site for a 100-year, 7-day design storm, corresponding to 9.8 to 10.0 inches depending on the site's location as shown on the 100-year, 7-day Isopluvial Maps, AND
- 2) It must be demonstrated that the downstream conveyance system has the capacity to carry the resultant flows without overflowing, AND
- 3) Appropriate water quality treatment is provided as required. AND
- 4) Conservation flow control is provided

Additional detention and release rate requirements may be required by the Washington State Department of Fish and Wildlife when a Hydraulic Project Approval (HPA) is required by the agency, or by the City to mitigate for conveyance problems downstream of the development or for impacts to critical areas.

For the **S 259th/3rd Avenue Regional Detention facility** (refer to flow control map) the above conditions shall apply with the exemption that only one-half of the Green River Management Agreement flood storage volume shall be required.

Flow Control Requirements for Horseshoe Acres and Union Pacific Pump Stations

Developments within the service areas draining to the Horseshoe Acres and Union Pacific Pump Stations along the Green River are required to provide on-site Conservation flow control and are required to provide on-site water quality treatment.

Release rates and/or detention requirements may be imposed by the City when the Applicant's downstream analysis indicates that the existing stormwater conveyance system from the development to the pump station does not have the necessary capacity to carry the increased flows, OR the pump station does not have the capacity to store and/or pump the additional runoff flows without local flooding.

Appropriate off-site mitigation measures to off-set identified conveyance or pumping constraints may be proposed by the Applicant and accepted at the discretion of the Director.

Area-specific Regional Facilities

Stormwater detention and treatment are not required for any development that discharges to the **Valley Regional Detention/Enhanced Wetland Facility** also known as the **Green River Natural Resource Area** (see the flow control applications map for the relevant subbasin boundary). The facility has been sized to provide detention and treatment for both existing and future developments.

Stormwater treatment and detention are required for any development that discharges to the **98th Avenue South Regional Treatment/Retention Pond** because this system is designed to handle existing erosion problems and is not designed to provide adequate detention and treatment according to current standards for existing or future developments.

Stormwater detention and treatment are also required for any development that discharges to the **Meridian Meadows (Springwood) Regional Detention Pond/Wetland Facility** or the **Upper or Lower Mill Creek Regional Detention Facilities**. These facilities were not designed to provide regional detention or treatment according to current standards for existing or future developments.

Master Drainage Plans have been approved for **Kentview** and **The Lakes** development areas (shown on the Flow Control Applications Map). Drainage standards applied within these areas shall be in accordance with the provisions of the respective Master Drainage Plans.

1.2.3.1 AREA-SPECIFIC FLOW CONTROL FACILITY REQUIREMENT

R
E
Q Projects subject to Core Requirement #3 must, **at a minimum, comply with the** area-specific flow control standards per the threshold information detailed in this section. These standards are described below.

Guide to Applying the Area-Specific Flow Control Facility Requirement

The flow control facility requirement varies across the city landscape according to the flow control area within which the project or a threshold discharge area of the project is located. Flow control areas are designated by the city to target the level of flow control performance to the broad protection needs of specific basins or subbasins.

There are currently nine such flow control areas, which are depicted on the Flow Control Applications Map adopted with this manual:

- **Conservation Flow Control Areas**
- **Flood Problem Flow Control Areas**
- **Green River Natural Resource Area regional FC facility**
- **Green River Management Agreement FC Areas**
- **Riverview Basin Plan FC Area,**
- **Lakes Regional Detention FC Area**
- **Horseshoe Acres FC Area**
- **Union Pacific Pump Station Area**
- **S. 259th/3rd Ave. S. Regional Detention Area**

Each flow control area has an area-specific set of minimum flow control facility performance criteria, design assumptions, surfaces that must be mitigated, and exceptions. These provisions all comprise what is referred to as the "area-specific flow control facility requirement."

Note that the minimum required performance of the facility as specified by this requirement may need to be increased to ensure that downstream drainage problems are not created or significantly aggravated as set forth in Section 1.2.2.2, "Drainage Problem-Specific Mitigation Requirements." Table 1.2.3.A provides a quick guide for selecting the flow control performance criteria necessary to meet both the area-specific flow control facility requirement and the problem-specific mitigation requirement. This is further explained in Step 4 below.

For efficient application of the flow control facility requirement, the following steps are recommended:

1. Use the Flow Control Applications Map to determine the flow control area in which your project is located.
2. Consult the detailed requirement and exception language for the identified flow control area to determine if and how the flow control facility requirement applies to your project. This requirement and exception language is detailed on subsequent pages for each of the nine flow control areas depicted on the Flow Control Applications Map. If a flow control facility is not applicable per the area-specific exceptions, proceed to Step 6.
3. If downstream drainage problems were identified through offsite analysis per Core Requirement #2 and are proposed to be addressed through onsite flow control, use Table 1.2.3.A to determine if and what additional flow control performance is necessary to mitigate impacts (i.e., to prevent creation or aggravation of the identified problems).
4. Use Section 1.2.3.2 to identify the applicable requirements for implementing the flow control facility requirement. These requirements cover facility siting, analysis and design, unusual situations, and other site-specific considerations.
5. Use Core Requirement 9 to identify the flow control BMPs that must be applied to your *project site* regardless of whether a flow control facility is required.

**TABLE 1.2.3.A
SUMMARY OF FLOW CONTROL PERFORMANCE CRITERIA ACCEPTABLE FOR IMPACT MITIGATION⁽¹⁾**

AREA-SPECIFIC STANDARD		
Identified Problem	Conservation FC Areas	Flood Problem FC Areas
No Problem Identified Apply the minimum area-specific flow control performance criteria.	Apply the <i>historic site conditions</i> Level 2 flow control standard, which matches historic durations for 50% of 2-yr through 50-year peaks AND matches historic 2- and 10- year peaks	Apply the <i>existing</i> or <i>historic site conditions</i> Level 2 flow control standard (whichever is appropriate based on downstream flow control area) AND match <i>existing site conditions</i> 100-year peaks
Type 1 Drainage Problem Conveyance System Nuisance Problem	<u>Additional Flow Control</u> <i>No additional flow control or other mitigation is needed</i>	<i>No additional flow control or other mitigation is needed</i>
Type 2 Drainage Problem Severe Erosion Problem	<i>No additional flow control is needed, but other mitigation may be required⁽⁴⁾</i>	<i>No additional flow control is needed, but other mitigation may be required⁽⁴⁾</i>
Type 3 Drainage Problem Severe Flooding Problem	<u>Additional Flow Control</u> Apply the <i>historic site conditions</i> Level 3 flow control standard. If flooding is from a closed depression, make design adjustments as needed to meet the special provision for closed depressions ⁽³⁾⁽⁵⁾	<u>Additional Flow Control</u> If flooding is from a closed depression, make design adjustments as needed to meet the special provision for closed depressions ⁽³⁾⁽⁵⁾
Type 4 Potential Impact to Wetland Hydrology as Determined through a Critical Area Review per KCC 11.06 or Offsite Analysis	<u>Additional Flow Control</u> ECD may require design adjustments per the wetland hydrology protection guidelines in Reference Section 5	<u>Additional Flow Control</u> ECD may require design adjustments per the wetland hydrology protection guidelines in Reference Section 5

Notes:

- ⁽¹⁾ More than one set of problem-specific performance criteria may apply if two or more downstream problems are identified through offsite analysis per Core Requirement #2. If this happens, the performance goals of each applicable problem-specific criteria must be met. This can require extensive, time-consuming analysis to implement multiple sets of outflow performance criteria if additional onsite flow control is the only viable option for mitigating impacts to these problems. In these cases, it may be easier and more prudent to implement the **historic site conditions Level 3 flow control standard** in place of the otherwise required area-specific standard. Use of the historic Level 3 flow control standard satisfies the specified performance criteria for all the area-specific and problem-specific requirements except if adjustments are required per the special provision for closed depressions described below in Note 5.
- ⁽²⁾ Overflow T_r is the return period of conveyance system overflow. To determine T_r requires a minimum level 2 downstream analysis as detailed in Section 2.3.1.1. To avoid this analysis, a T_r of 2 years may be assumed.
- ⁽³⁾ Offsite improvements may be implemented in lieu of or in combination with additional flow control as allowed in Section 1.2.2.2 and detailed in Section 3.3.5.
- ⁽⁴⁾ A tightline system may be required regardless of the flow control standard being applied if needed to meet the discharge requirements of Core Requirement #1 or the outfall requirements of Core Requirement #4, or is deemed necessary by Economic and Community Development where the risk of severe damage is high.
- ⁽⁵⁾ **Special Provision for Closed Depressions with a Severe Flooding Problem:**
If the proposed project discharges by overland flow or conveyance system to a closed depression experiencing a severe flooding problem AND the amount of impervious surface area proposed by the project is greater than or equal to 10% of the 100-year water surface area of the closed depression, THEN use the point of compliance analysis technique described in Section 3.3.6 to verify that water surface levels are not increasing for the return frequencies at which flooding occurs, up to and including the 100-year frequency. If necessary, iteratively adjust onsite flow control performance to prevent increases. *Note: The point of compliance analysis relies on certain field measurements taken directly at the closed depression (e.g., soils tests, topography, etc.). If permission to enter private property for such measurements is denied, city review staff may waive this provision and apply the Level 3 flow control standard with a mandatory 20% safety factor on the storage volume.*

IMPERVIOUS SURFACE PERCENTAGE EXEMPTION FOR AGRICULTURAL PROJECTS

For agricultural projects located within an Agricultural Production District (APD), Farmland Preservation Program (FPP), or site zoned A, any onsite threshold discharge area is exempt from the flow control facility requirement if it meets all of the following conditions:

- a) The total (new, replaced, and existing) amount of impervious surface that is not fully dispersed per the criteria on page 1-46 must be no more than 4% of the threshold discharge area, AND
- b) New impervious surfaces and new pervious surfaces must not disturb, impact, or replace native vegetation, AND
- c) Flow control BMPs must be applied to new impervious surfaces as specified in Core Requirement 9, AND
- d) All impervious surface area, except 10,000 square feet of it, must be set back from its natural location of discharge from the site at least 100 feet for every 10,000 square feet of total impervious surface and its runoff must be discharged in an unconcentrated manner that promotes infiltration and evapotranspiration, AND
- e) Increased runoff from the new impervious surface and new pervious surface must not significantly impact a critical area, severe flooding problem, or severe erosion problem, AND
- f) The manner in which runoff is discharged from the project site must not create a significant adverse impact per core requirement #1.

BASIC FLOW CONTROL AREAS

Basic flow control (Level 1) is not permitted anywhere in Kent.

CONSERVATION FLOW CONTROL AREAS

Conservation Flow Control Areas cover most developable areas of Kent. Conservation Flow Control Areas are the default designation unless otherwise indicated on the City of Kent Flow Control Applications Map adopted with this manual.

*Note: For projects located at or near the delineated boundary of the Conservation Flow Control Area, site specific topography or drainage information may be needed to verify that a project or any **threshold discharge area** of a project is within the flow control area. Any **threshold discharge area** is considered to be within the Conservation Flow Control Area if the **threshold discharge area** drains to a waterbody or drainage system that is clearly within the mapped Conservation Flow Control Area.*

Minimum Required Performance

R
E
Q
M

Facilities in **Conservation Flow Control Areas** must comply with the following flow control performance standard and assumptions unless modified by offsite analysis per Core Requirement #2 (see Table 1.2.3.A).

Level 2 Flow Control: Match developed discharge durations to predeveloped durations for the range of predeveloped discharge rates from 50% of the 2-year peak flow up to the full 50-year peak flow. Also match developed peak discharge rates to predeveloped peak discharge rates for the 2- and 10-year return periods. Assume *historic site conditions* as the predeveloped condition.

Intent

The Level 2 flow control standard assuming *historic site conditions* is intended to limit the amount of time that erosive flows are at work generating erosion and sedimentation within natural and constructed drainage systems. Such control is effective in preventing development-induced increases in natural erosion rates and reducing existing erosion rates where they may have been increased by past development of the *site*. This is accomplished by maintaining at historic predevelopment levels the aggregate time that developed flows exceed an erosion-causing threshold (i.e., 50% of the historic 2-year peak flow). Maintaining natural erosion rates within streams and their tributary areas is important for preventing

increases in stream channel erosion and sediment loading that are detrimental to salmonid habitat and production.

Effectiveness in Addressing Downstream Problems

While the Level 2 flow control standard assuming *historic site conditions* provides a reasonable level of protection for preventing most development-induced problems, it does not necessarily prevent increases in *existing site conditions* 100-year peak flows that can aggravate *severe flooding problems* as described in Core Requirement #2, nor does it necessarily prevent aggravation of all *severe erosion problems*. Consequently, if one or more of these problems are identified through offsite analysis per Core Requirement #2, additional onsite flow control and/or offsite improvements will likely be required (see "Drainage Problem-Specific Mitigation Requirements" in Section 1.2.2.2).

Target Surfaces

Facilities in **Conservation Flow Control Areas** must mitigate (either directly or in effect) the runoff from the following target developed surfaces within the *threshold discharge area* for which the facility is required:

1. **New impervious surface** that is **not fully dispersed** or not farmland dispersed as specified in Appendix C. For individual lots within residential subdivision projects, the extent of **new impervious surface** shall be assumed as specified in Chapter 3.
2. **New pervious surface** that is **not fully dispersed** or not farmland dispersed as specified in Appendix C. For individual lots within residential subdivision projects, the extent of **new pervious surface** shall be assumed to be the entire lot area, except the assumed impervious portion and any portion in which native conditions are preserved by covenant, tract, or easement. In addition, the **new pervious surface** on individual lots shall be assumed to be 100% grass.
3. **Existing impervious surface** added since January 8, 2001 that is **not fully dispersed** or not farmland dispersed as specified in Appendix C, and not yet mitigated with a City-approved flow control facility or flow control BMP. *Note: January 8, 2001 is the effective date of the ESA 4(d) Rule for Puget Sound Chinook salmon.*
4. **Replaced impervious surface** that is **not fully dispersed** or not farmland dispersed as specified in Appendix C on a non-redevelopment project in which the total of new plus replaced impervious surface is 5,000 square feet or more, OR new pervious surface is $\frac{3}{4}$ acre or more.
5. **Replaced impervious surface** that is **not fully dispersed** on a **transportation redevelopment project** in which **new impervious surface** is 5,000 square feet or more and totals 50% or more of the existing impervious surface within the project limits.
6. **Replaced impervious surface** that is **not fully dispersed** or not farmland dispersed as specified in Appendix C, on a **parcel redevelopment project** in which the total of new plus **replaced impervious surface** is 5,000 square feet or more and whose valuation of proposed improvements (including interior improvements and excluding required mitigation improvements) exceeds 50% of the assessed value of: (a) the existing project site improvements on commercial or industrial projects or (b) the existing site improvements on other projects.

Exceptions

The following exceptions apply only in Conservation Flow Control Areas:

1. The historic site conditions assumption for application of Level 2 flow control may be reduced through a basin plan or study approved by the City and the Washington State Department of Ecology.

One possible reduction is to an assumption of 75% forest, 15% grass, and 10% impervious surface (75/15/10 conditions) or existing site conditions, whichever generates the lowest 100-year peak flow. Another possible change that could be made through a City and Ecology approved basin plan or study is to the lowest peak flow (50% of the 2-year peak flow) above which discharge durations must be matched. This peak flow, known as the geomorphic threshold of bed load movement, may be changed based on the actual channel conditions necessary to protect or allow for restoration of water body beneficial uses and habitat functions essential to salmonids.

2. The facility requirement in Conservation Flow Control Areas is waived for any threshold discharge area in which there is no more than a 0.15-cfs difference (when modeled using 15 minute time steps) or no more than a 0.1-cfs difference (when modeled using 1 hour time steps) in the sum of developed 100-year peak flows for those target surfaces subject to this requirement and the sum of historic site conditions 100-year peak flows (modeled using same time step unit (e.g., hourly or 15 minute) used to calculate the developed flow) for the same surface areas. Agricultural zoned projects in current agricultural use may use existing site conditions as the predeveloped condition for purposes of this exception calculation. Note: for the purposes of this calculation, target surfaces served by flow control BMPs per Appendix C may be modeled in accordance with the flow control BMP facility sizing credits in Core Requirement 9, Table 1.2.9.A.
3. The facility requirement in Conservation Flow Control Areas may be reduced or waived for any threshold discharge area where a plan or study approved by the City and Ecology shows that a lower standard (e.g., Level 1 flow control) is sufficient or no facility is necessary to protect or allow for restoration of water body beneficial uses and habitat functions essential to salmonids.
4. The facility requirement in Conservation Flow Control Areas as applied to replaced impervious surface may be waived if the City has adopted a plan and implementation schedule approved by state Department of Ecology for fulfilling this requirement in regional facilities.
5. The facility requirement in Conservation Flow Control Areas as applied to replaced impervious surface may be reduced by DPER using the procedures detailed in Sections 1.4.3 and 1.4.4 of the adjustment process, if the cost of flow control facilities to mitigate all target surfaces exceeds that necessary to mitigate only for new impervious surface plus new pervious surface and also exceeds 1/3 of the valuation of proposed improvements (including interior improvements) or twice the cost of a facility to mitigate equivalent surfaces on a new development site, whichever is less.

❑ FLOOD PROBLEM FLOW CONTROL AREAS

Flood Problem Flow Control Areas are designated by the City of Kent where it has been determined that a higher average level of flow control is needed to prevent aggravation of existing documented flooding or erosion problems. Such areas are delineated on the Flow Control Applications Map.

Note: For projects located at or near the delineated boundary of the Flood Problem Flow Control Area, site-specific topography or drainage information may be needed to verify that a project or any **threshold discharge area** of a project is within the flow control area. Any **threshold discharge area** is considered to be within the Flood Problem Flow Control Area if the **threshold discharge area** drains to a waterbody or drainage system that is clearly within the mapped Flood Problem Flow Control Area.

Minimum Required Performance

Facilities in **Flood Problem Flow Control Areas** must comply with the following flow control performance standard and assumptions unless modified by offsite analysis per Core Requirement #2 (see Table 1.2.3.A).

Level 3 Flow Control: Apply the Level 2 flow control standard, AND match the developed 100-year peak discharge rate to the predeveloped 100-year peak discharge rate. If the Flood Problem Flow Control Area is located within a Conservation Flow Control Area, then *historic site conditions* shall be assumed as the predeveloped condition except for the purposes of matching 100-year peak discharge rates. For all other

situations and for the purposes of matching 100-year peak discharge rates, *existing site conditions* may be assumed.

Intent

The Level 3 flow control standard is intended to prevent significant increases in existing water surface levels for 2-year through 100-year return frequencies. Such increases are expected to occur as the volume of runoff discharging to the water body is increased by upstream development. Because inflow rates to these water bodies are typically much higher than the outflow rates, increased runoff volumes from upstream development are, in effect, stacked on top of existing volumes in the water body, resulting in higher water surface levels. The duration-matching and 100-year peak-matching criteria of the Level 3 flow control standard counteract this stacking effect by slowing the arrival of additional runoff volumes. Because it can prevent significant aggravation of existing flooding, the Level 3 standard is also applicable to other flow control areas where *severe flooding problems* have been identified per Core Requirement #2.

Effectiveness in Addressing Downstream Drainage Problems

If the Level 3 flow control standard is implemented onsite, no additional measures are required to prevent aggravation of the three types of downstream drainage problems described in Core Requirement #2. The one exception is for a wetland or lake that is a closed depression with a *severe flooding problem*, and the proposed project is adding impervious surface area amounting to more than 10% of the 100-year water surface area of the closed depression. In this case, additional onsite flow control or offsite improvements may be necessary as determined by a "point of compliance analysis" (see "Special Provision for Closed Depressions" in Table 1.2.3.A and see Section 3.3.6, "Point of Compliance Analysis").

Target Surfaces

Facilities **in Flood Problem Flow Control Areas** must mitigate (either directly or in effect) the runoff from the following target developed surfaces within the *threshold discharge area* for which the facility is required:

1. The target surfaces are the same as those required for facilities in Conservation Flow Control Areas unless otherwise allowed by the area-specific exceptions for Conservation Flow Control Areas.

Exceptions

The following exceptions apply only **in Flood Problem Flow Control Areas**:

1. Any required application of the Flood Problem Flow Control Areas facility requirement to *replaced impervious surface* may be waived if the City has adopted a plan and implementation schedule approved by the state Department of Ecology for fulfilling this requirement with regional facilities.
2. Any required application of the Flood Problem Flow Control Areas facility requirement to *replaced impervious surface* may be reduced by the Economic and Community Development Department using the procedures detailed in Sections 1.4.3 and 1.4.4 of the adjustment process, if the **cost of flow control facilities** to mitigate all target surfaces exceeds that necessary to mitigate only for *new impervious surface* plus *new pervious surface* and also exceeds $\frac{1}{3}$ of the valuation of proposed improvements (including interior improvements) or twice the cost of a facility to mitigate the same surfaces on a new *development site*, whichever is less. The amount of reduction allowed by this exception shall be limited such that the **cost of flow control facilities** is at least equal to that necessary to mitigate only for *new impervious surface* plus *new pervious surface*, and beyond this amount, is no greater than $\frac{1}{3}$ of the valuation of proposed improvements (including interior improvements) or twice the cost of a facility to mitigate equivalent surfaces on a new *development site*, whichever is less.
3. Any required application of the Flood Problem Flow Control Areas facility requirement to *replaced impervious surface* may assume *existing site conditions* as the predeveloped condition for the

purposes of matching the developed 100-year peak discharge rate to the predeveloped 100-year peak discharge rate.

1.2.3.2 FLOW CONTROL FACILITY IMPLEMENTATION REQUIREMENTS

Flow control facilities shall be designed and implemented in accordance with the following requirements, allowances, and flexible compliance provisions:

Onsite vs. Offsite Implementation

All required flow control facilities must be implemented onsite except where the below requirements can be met for direct discharge to a regional or shared facility constructed to provide flow control for the proposed project. Regional facilities are typically constructed as part of a basin plan. Shared facilities may be constructed under a City-developed shared facility drainage plan or under an agreement between two or more private developers. These requirements apply to proposed *new* facilities. The relationship between onsite and offsite implementation for *existing* regional facilities is described under “Exemptions from Core Requirement 3”.

1. The regional or shared facility must be of adequate size and design to meet the **current** flow control requirements for the proposed project’s increased surface and stormwater runoff. *Note: the current flow control requirements are those specified by Core Requirement #3 of this manual unless superseded by other adopted area-specific flow control requirements per Special Requirement #1 (see Section 1.3.1).* In some cases where the current flow control requirements differ from those used to originally design the regional or shared facility, additional analysis and possible retrofitting of the facility may be required to ensure adequate size and design.
2. The regional or shared facility must be fully operational at the time the proposed project is constructed. In the case of a shared facility, the proposed project must comply with the terms and conditions of all contracts, agreements, and permits associated with the shared facility.
3. The conveyance system between the **project site** and the regional facility must be approved by city review staff and meet all the following criteria:
 - a) The conveyance system between the project site and the ordinary high water line of the regional facility shall be comprised of manmade conveyance elements (pipes, ditches, outfall protection, etc.) and shall be within public right-of-way or a public or private drainage easement, AND
 - b) The conveyance system shall have **adequate capacity** per Core Requirement #4, Conveyance System, for the entire contributing drainage area, assuming **build-out conditions** to current zoning for the **equivalent area** portion (defined in Figure 1.2.3.A below) and existing conditions for the remaining area, AND
 - c) The conveyance system will be adequately stabilized to prevent erosion, assuming the same basin conditions as assumed in Criterion (b), AND
 - d) The conveyance system will not divert flows from or increase flows to an existing wetland or stream sufficient to cause a significant adverse impact.

In the case of a shared facility, the criteria are the same, except the conveyance system need only have adequate capacity and erosion protection for buildout of the participating portion of the contributing drainage area. The participating portion includes those properties that have agreements for use of the shared facility.

Methods of Analysis and Design

Flow control facilities must be analyzed and designed using a continuous flow simulation method such as HSPF (Hydrologic Simulation Program–FORTRAN) or the simplified HSPF-based runoff files method. Specifications for use of the runoff files method and associated computer program, Western Washington Hydrologic Model, (WWHM3), are found in Chapter 3. Detailed design specifications for flow control facilities are found in Chapter 5.

Flow control facilities to be constructed on the **Valley floor** (below elevation 35 feet) shall take into account the anticipated Valley floor flood levels in the facility design. The facility is to be designed assuming a freely draining outlet, but potential onsite flooding and facility performance should be evaluated **considering tailwater conditions** that can exist due to Valley floor flooding for up to the 100-year flood. This evaluation shall be completed by routing the 100-year flood through the site storm drain/detention pond system considering high tailwater conditions (100-year flood). Potential onsite flooding needs to be identified and an overflow is to be provided that is capable of conveying the 100-year peak flood flow from the site in accordance with these conditions:

1. The overflow shall be directed to and released at the natural location without causing risk or damage to downstream properties, AND
2. No flooding of traffic lanes will occur, AND
3. No structural flooding will occur.

Developments sited on the Valley floor within the FEMA mapped floodplain will also be required to include **compensatory flood storage** volumes. This volume shall be calculated as 100% of the flood storage volume lost from the 100-year floodplain when comparing pre- and post-development conditions. Compensatory flood volumes can be added to the on-site flow control facility after the flow control volume has been determined. Storage volumes required for flow control will not be credited toward compensatory flood volumes (see Special Requirement #2, Section 1.3.2).

SIZING CREDITS FOR FULLY DISPERSED SURFACES

A **fully dispersed** surface (either impervious or non-native pervious) is one that conforms to the BMP strategy for "full dispersion" detailed in Appendix C, Section C.2.1. This strategy calls for minimizing the area of onsite developed surface relative to **native vegetated surface**, together with the application of dispersion techniques that utilize the natural retention/detention capacity of the **native vegetated surface** to mitigate the runoff effects of the developed surfaces. Developed surfaces conforming to this strategy are considered to have a negligible impact downstream, and therefore, may be modeled as forest and are not subject to the area-specific flow control facility requirement (Section 1.2.3.1) or the area-specific water quality facility requirement (Section 1.2.8.1). In order for developed surfaces to qualify as **fully dispersed**, they must meet the basic criteria listed below and further detailed in Appendix C, Section C.2.1.

Criteria for Fully Dispersed Surfaces

1. The **total area of impervious surface** being **fully dispersed** must be no more than 15% of the total area of **native vegetated surface** being preserved by a clearing limit per KCC 16.82 or by recorded tract, easement, or covenant within the same **threshold discharge area**. The total area of impervious surface plus *non-native pervious surface* being **fully dispersed** must be no more than 35% of a **threshold discharge area**.
2. The runoff from a **fully dispersed** surface must be discharged using one of the following **dispersion devices** in accordance with the design specifications and maximum area of **fully dispersed** surface for each device set forth in Appendix C, Section C.2.1:

- a) **Splash blocks**
- b) **Rock pads**
- c) **Gravel filled trenches**
- d) **Sheet flow**

*Note: The dispersion device must be situated so as to discharge within the same **threshold discharge area** of the surface it serves.*

3. A **native vegetated flowpath segment** of at least 100 feet in length (25 feet for sheet flow from a nonnative pervious surface) must be available along the flowpath that runoff would follow upon discharge from a dispersion device listed in Minimum Requirement 2 above. The native vegetated flowpath segment **must meet all of the following criteria:**
 - a) The flowpath segment must be over *native vegetated surface*.
 - b) The flowpath segment must be **onsite or an offsite tract or easement area** reserved for such dispersion.
 - c) The **slope** of the flowpath segment must be **no steeper than 15%** for any 20-foot reach of the flowpath segment.
 - d) The flowpath segment must be located **between the dispersion device and any downstream drainage feature** such as a pipe, ditch, stream, river, pond, lake, or wetland.
 - e) The flowpath segments for adjacent dispersion devices must comply with the **minimum spacing requirements** in Appendix C, Section C.2.1. These requirements do not allow overlap of flowpath segments, except in the case where **sheet flow from a non-native pervious surface** overlaps with the flowpath of any dispersion device listed in Minimum Requirement 2 above. In this case, the longer of the two overlapping flowpath segments must be extended at least 1 foot for every 3 feet of distance along the most representative path that runoff would travel from the upstream end to the discharge end of the non-native pervious surface.
4. On **sites with septic systems**, the discharge of runoff from dispersion devices must not be upgradient of the drainfield. This requirement may be waived by city review staff if *site* topography clearly prohibits flows from intersecting the drainfield.
5. The dispersion of runoff must not create **flooding or erosion impacts** as determined by city review staff. If runoff is proposed to be discharged toward a **landslide hazard area, erosion hazard area, or steep slope hazard area** (i.e., slopes steeper than 20%), city review staff may require the applicant to have the proposal evaluated by a geotechnical engineer or engineering geologist.

SIZING CREDITS FOR USE OF FLOW CONTROL BMPS

Projects that implement flow control BMPs as detailed in Core Requirement 9 and Appendix C, whether required or optional, may use the flow control BMP modeling credits as described and allowed in Section 1.2.9.4 and Table 1.2.9.A.

MITIGATION OF TARGET SURFACES THAT BYPASS FACILITY

On some *sites*, topography may make it difficult or costly to collect all target surface runoff for discharge to the onsite flow control facility. Therefore, some project runoff subject to flow control may bypass required onsite flow control facilities provided that all of the following conditions are met:

1. The **point of convergence** for runoff discharged from the bypassed target surfaces and from the project's flow control facility must be within a **quarter-mile downstream**²⁸ of the facility's **project site** discharge point, AND

2. The increase in the *existing site conditions* **100-year peak discharge** from the area of bypassed target surfaces must not exceed 0.4 cfs, AND
3. Runoff from the bypassed target surfaces **must not create a significant adverse impact** to downstream drainage systems, salmonid habitat, or properties as determined by Economic and Community Development, AND
4. **Water quality requirements** applicable to the bypassed target surfaces must be met, AND
5. **Compensatory mitigation by a flow control facility** must be provided so that the net effect at the point of convergence downstream is the same with or without the bypass. This mitigation may be waived if the *existing site conditions* 100-year peak discharge from the area of bypassed target surfaces is increased by no more than 0.1 cfs (modeled using 1 hour time steps) or no more than 0.15 cfs (modeled using 15 minute time steps) and **flow control BMPs** as detailed in Appendix C are applied to all impervious surfaces within the area of bypassed target surfaces. One or combination of the following methods may be used to provide compensatory mitigation by a flow control facility subject to permission/approvals from other parties as deemed necessary by Economic and Community Development:
 - a) Design the project's flow control facility or retrofit an existing offsite flow control facility as needed to achieve the desired effect at the point of convergence, OR
 - b) Design the project's flow control facility or provide/retrofit an offsite flow control facility to mitigate an existing developed area (either onsite or offsite) that has runoff characteristics (i.e., peak flow and volume) equivalent to those of the bypassed target surfaces but is currently not mitigated or required to be mitigated to the same flow control performance requirement as the bypassed target surfaces.

BYPASS OF RUNOFF FROM NON-TARGET SURFACES

IF the existing 100-year peak flow rate from any upstream offsite area (not targeted for mitigation) is greater than 50% of the 100-year developed peak flow rate (undetained) for the area that must be mitigated, THEN the runoff from the offsite area must bypass onsite flow control facilities. The bypass of offsite runoff must be designed so as to achieve all of the following:

1. Any existing contribution of flows to an onsite wetland must be maintained, AND
2. Offsite flows that are naturally attenuated by the project site under predeveloped conditions must remain attenuated, either by natural means or by providing additional onsite detention so that peak flows do not increase, AND
3. Offsite flows that are dispersed or unconcentrated on the project site under predeveloped conditions must be discharged in a safe manner as described in Core Requirement #1 under "Discharge Requirements."

MITIGATION TRADES

A project's flow control facility may be designed to mitigate an existing developed non-target surface area (either onsite or offsite) in trade for not mitigating part or all of the project's target surface area, provided that the arrangement is approved by the city **and** all of the following conditions are met:

1. The **existing developed non-target surface area** (i.e., an area of existing impervious surface and/or non-native pervious surface) must have runoff discharge characteristics (i.e., peak flow and volume) equivalent to those of the target surface area for which mitigation is being traded and must not be currently mitigated to the same flow control performance requirement as the target surface area, AND

2. Runoff from both the target surface area being traded and the flow control facility **must converge prior to discharge** of the runoff from the target surface area being traded onto private property without an easement or through any area subject to erosion, AND
3. The **net effect** in terms of flow control at the point of convergence downstream must be the same with or without the mitigation trade, AND
4. The undetained runoff from the target surface area being traded **must not create a significant adverse impact** to downstream drainage systems, salmonid habitat, or properties prior to convergence with runoff from the flow control facility.
5. The existing non-targeted surface area that is mitigated for purposes of required flow control must be documented and tracked by city review staff. Documentation should clarify that future redevelopment of this existing non-targeted area used for the mitigation trade will incur additional flow control mitigation requirements if the redevelopment exceeds Core Requirement #3 thresholds. This additional flow control mitigation must be met in addition to that previously required and provided for the mitigation trade. Applicants may be advised to size flow control facilities sufficient for both the mitigation trade area and future development of the existing non-targeted area

FACILITY REQUIREMENT IN LANDSLIDE HAZARD DRAINAGE AREAS

Proposed projects subject to Discharge Requirement 2 in Core Requirement #1 must provide a tightline system except where city review staff approves an alternative system based on a geotechnical analysis that considers cumulative impacts from the project and surrounding areas under full built-out conditions, AND one of the following conditions can be met:

- a) Less than 2,000 square feet of *new impervious surface* will be added within the *natural discharge area*, OR
- b) The developed conditions runoff from the *natural discharge area* is less than 0.1 cfs for the 100-year runoff event and will be infiltrated for runoff events up to and including the 100-year event, OR
- c) The *developed conditions runoff volume* from the *natural discharge area* is less than 50% of the existing conditions runoff volume from other areas draining to the location where runoff from the *natural discharge area* enters the *landslide hazard area* onto slopes steeper than 15%, AND the provisions of Discharge Requirement 1 are met, OR
- d) *City review staff* determines that a tightline system is not physically feasible or will create a significant adverse impact based on a soils report by a geotechnical engineer.

Systems proposed as an alternative to the required tightline must meet all of the following requirements:

1. Approval by the city shall be based on a geotechnical analysis that considers cumulative impacts from the project and surrounding areas under full built-out conditions.
2. Proposed facilities, FCBMPs, and dispersal systems must meet all applicable feasibility and setback requirements contained in the SWDM.
3. Facility outflows must meet the discharge dispersal requirements specified in Discharge Requirement 1 of Core Requirement #1.
4. The geotechnical analysis and proposed system design must address facility overflows and recommend additional measures, factors of safety in facility design, etc. based on an evaluation of risk of slope instability or failure and potential impacts to life, structures, and property.

5. For projects adjacent to or containing a *landslide, steep slope, or erosion hazard area* as defined in KCC 11.06, the applicant must demonstrate that onsite drainage facilities and/or flow control BMPs will not create a significant adverse impact to downhill properties or drainage systems.

Manifold Detention Facilities

A *manifold detention facility* is a single detention facility designed to take the place of two or more otherwise required detention facilities. It combines the runoff from two or more onsite drainage areas having separate natural discharge points, and redistributes the runoff back to the natural discharge points following detention. Because manifold detention facilities divert flows from one natural discharge point to another and then back, they are not allowed except by an approved adjustment (see Section 1.4, “Adjustment Process”).

Use of Underground Detention Facilities

Open detention ponds are preferred over underground detention facilities (vaults or tanks) because open vegetated ponds provide additional stormwater treatment in addition to quantity controls.

Underground vaults or tanks shall only be permitted to meet detention requirements with the following conditions fully implemented:

1. All landscaping on the development site, including individual lots and open spaces, must strictly comply with soil depth and amendment requirements outlined in Kent City Code Chapter 15.07.
2. All vaults must be thoroughly cleaned, and all filters changed after construction is complete and prior to the release of any financial guarantees.
3. Vaults are not allowed in the City right of way.
4. Vaults shall be “Infiltration Vaults” as per Chapter 5, section 5.2.4 of the King County SWDM unless site or project conditions warrant otherwise as determined by a geotechnical engineering report to be reviewed and approved by the development engineering reviewer. The applicant shall submit a geotechnical report that addresses the viability of a bottomless infiltration vault. Special consideration should be given to the effect of groundwater on vault functionality and capacity.
5. Bottomless vault bottom must be at or above the seasonal high groundwater level for Infiltration Vaults used for detention purposes.
6. Vaults are allowed when the water draining to them is from private property and the vault is privately owned and maintained. For cases where the facility receives runoff from public Right-of-Way, vaults (and associated water quality facilities) will be maintained by the city and the associated property owners shall reimburse the city for the maintenance. The responsibility to reimburse the city for required maintenance shall be memorialized in a recorded Stormwater Facility Maintenance Covenant recorded against the property. For subdivisions, the homeowner’s responsibility to reimburse the city for maintenance shall be included on the face of the recorded subdivision and be included in the subdivision’s Covenants, Conditions & Restrictions, (CC&R’s). The CC&R’s shall be recorded in conjunction with the Final Subdivision.

No credit will be permitted toward required detention volumes for any element of the conveyance system.

Aquifer Recharge Areas

The City of Kent implements a wellhead protection program to protect and preserve regional groundwater resources. This program is critical to the City to ensure that the water supply obtained from groundwater is maintained at the highest quantity and quality levels possible. Protection of quantity and quality of

groundwater is also important to the City and regional interests due to the linkage between groundwater and surface water. Baseflow represents a high percentage of streamflow in the dry summer months in the Puget Sound Region.

To work towards protection of the groundwater resource, the City of Kent, Covington Water District, and Water District 111 have designated and mapped “Wellhead Protection Areas”. These areas are shown on the Soils/Wellhead Area Map included with this manual in the cover pocket. **The City of Kent requires that any project located within Wellhead Protection Areas and subject to the requirements of this manual enhance or maintain groundwater recharge quantity and quality to the maximum extent possible.** This shall predominantly be achieved through the construction of infiltration facilities as described in Chapter 5 – Flow Control Design.

1.2.4 CORE REQUIREMENT #4: CONVEYANCE SYSTEM

R
E
Q
U
I
R
E
M
E
N
T

All engineered conveyance system elements for proposed projects must be analyzed, designed, and constructed to provide a minimum level of protection against overtopping, flooding, erosion, and structural failure as specified in the following groups of requirements:

- “Conveyance Requirements for New Systems,” Section 1.2.4.1
- “Conveyance Requirements for Existing Systems,” Section 1.2.4.2
- “Conveyance System Implementation Requirements,” Section 1.2.4.3

Intent: To ensure proper design and construction of engineered conveyance system elements.

Conveyance systems are natural and engineered drainage facilities that provide for the collection and transport of surface water or stormwater runoff. This core requirement applies to the engineered elements of conveyance systems—primarily pipes, culverts, and ditches/channels.

1.2.4.1 CONVEYANCE REQUIREMENTS FOR NEW SYSTEMS

All *new conveyance system elements*,¹⁸ both onsite and offsite, shall be analyzed, designed, and constructed according to the following requirements. All analyses shall examine the full range of anticipated tailwater conditions. Also see Section 4.1 for route design and easement requirements.

Pipe Systems

1. New pipe systems shall be designed with sufficient capacity to convey and contain (at minimum) the 25-year peak flow, assuming developed conditions for onsite tributary areas and existing conditions for any offsite tributary areas.
2. Pipe system structures may overtop for runoff events that exceed the 25-year design capacity, provided the overflow from a 100-year runoff event does not create or aggravate a ***severe flooding problem*** or ***severe erosion problem*** as defined in Core Requirement #2, Section 1.2.2. Any overflow occurring onsite for runoff events up to and including the 100-year event must discharge at the natural location for the ***project site***. In residential subdivisions, such overflow must be contained within an onsite drainage easement, tract, covenant, or public right-of-way.
3. The upstream end of a pipe system that receives runoff from an open drainage feature (pond, ditch, etc.) shall be analyzed and sized as a culvert as described below.

Culverts

1. New culverts shall be designed with sufficient capacity to meet the headwater requirements in Section 4.3.1 and convey (at minimum) the 25-year peak flow, assuming developed conditions for onsite tributary areas and existing conditions for any offsite tributary areas.
2. New culverts must also convey as much of the 100-year peak flow as is necessary to preclude creating or aggravating a ***severe flooding problem*** or ***severe erosion problem*** as defined in Core Requirement #2, Section 1.2.2. Any overflow occurring onsite for runoff events up to and including the 100-year event must discharge at the natural location for the ***project site***. In residential subdivisions, such

¹⁸ *New conveyance system elements* are those that are proposed to be constructed where there are no existing constructed conveyance elements.

overflow must be contained within an onsite drainage easement, tract, covenant, or public right-of-way.

3. New culverts proposed in streams with salmonids shall be designed to provide for fish passage based on current Washington State fish-passage laws and regulations.

Ditches/Channels

1. New ditches/channels shall be designed with sufficient capacity to convey and contain, at minimum, the 25-year peak flow, assuming developed conditions for onsite tributary areas and existing conditions for any offsite tributary areas.
2. New ditches/channels must also convey as much of the 100-year peak flow as is necessary to preclude creating or aggravating a *severe flooding problem* or *severe erosion problem* as defined in Core Requirement 2, Section 1.2.2. Any overflow occurring onsite for runoff events up to and including the 100-year event must discharge at the natural location for the *project site*. In residential subdivisions, such overflow must be contained within an onsite drainage easement, tract, covenant, or public right-of-way.

Tightline Systems Traversing Steep Slopes

New tightline conveyance systems traversing slopes that are steeper than 15% and greater than 20 feet in height, or are within a *steep slope hazard area* shall be designed with sufficient capacity to convey and contain (at minimum) the 100-year peak flow, assuming *full build-out conditions*¹⁹ for all tributary areas, both onsite and offsite. Tightline systems shall be designed as detailed in Section 4.2.2.

Bridges

New bridges shall be designed to pass the 100-year peak flow with clearance as specified in Section 4.3.3 and in accordance with the floodplain development standards in KCC 14.09.

1.2.4.2 CONVEYANCE REQUIREMENTS FOR EXISTING SYSTEMS

The following conveyance requirements for existing systems are less rigorous than those for new systems to allow some salvaging of existing systems that are in useable condition. Existing systems may be utilized if they are capable of providing a minimum level of protection as-is or with minor modifications.

Existing Onsite Conveyance Systems

No Change in Flow Characteristics: Existing onsite conveyance systems that will not experience a change in flow characteristics (e.g., peak flows or volume of flows) as a result of the proposed project need not be analyzed for conveyance capacity.

Change in Flow Characteristics: Existing onsite conveyance systems that will experience a change in flow characteristics as a result of the proposed project must comply with the following conveyance requirements:

1. The existing system must be analyzed and shown to have sufficient capacity to convey and contain (at minimum) the 10-year peak flow assuming developed conditions for onsite tributary areas and existing conditions for any offsite tributary areas.

¹⁹ *Full build-out conditions* means the tributary area is developed to its full zoning potential except where there are existing environmentally sensitive areas, open space tracts, and/or native growth protection easements/covenants.

2. The applicant must demonstrate that the 100-year peak flow to the existing system will not create or aggravate a *severe flooding problem* or *severe erosion problem* as defined in Core Requirement #2, Section 1.2.2.
3. Minor modifications may be made to the conveyance system to achieve the required capacity stated above. Examples of minor modifications include raising a catch basin rim, replacing or relaying a section of pipe to match the capacity of other pipes in the system, improving a pipe inlet, or enlarging a short, constricted reach of ditch or channel.
4. Modifications to an existing conveyance system or element that act to attenuate peak flows due to the presence of upstream detention storage shall be made in a manner that does not significantly increase peak flows downstream. For example, if water is detained in a pond upstream of a restrictive road culvert, then installing an overflow system for the culvert should prevent overtopping of the road without significantly reducing existing detention storage.

Existing Offsite Conveyance Systems

1. Existing offsite conveyance systems need not be analyzed for conveyance capacity except as required by Core Requirement #2, or if offsite improvements or direct discharge are proposed per Core Requirement #3.
2. Improvements made to existing offsite conveyance systems to address the problem-specific mitigation requirements in Section 1.2.2.2 need only change existing conveyance capacity sufficiently to prevent aggravation of the drainage problem(s) being addressed.

1.2.4.3 CONVEYANCE SYSTEM IMPLEMENTATION REQUIREMENTS

Conveyance systems shall be designed and implemented in accordance with the following requirements, allowances, and flexible compliance provisions:

Methods of Analysis and Design

Properly-sized conveyance elements provide sufficient hydraulic capacity to convey peak flows of the return frequencies indicated in Sections 1.2.4.1 and 1.2.4.2. Conveyance capacity shall be demonstrated using the methods of analysis detailed in Chapter 4. Design flows for sizing conveyance systems shall be determined using the appropriate runoff computation method specified in Section 3.2.

Spill Control Provisions

Projects proposing to construct or replace onsite conveyance system elements that receive runoff from non-roof-top *pollution-generating impervious surface* must provide a spill control device as detailed in Section 4.2.1 prior to discharge from the project *site* or into a *natural onsite drainage feature*.²⁰ More specifically, this requirement applies whenever a proposed project does either of the following:

- Constructs a new onsite conveyance system that receives runoff from non-roof-top *pollution-generating impervious surface*, OR
- Removes and replaces an existing onsite conveyance system element that receives runoff from 5,000 square feet or more of non-roof-top *pollution-generating impervious surface* onsite.

The intent of this device is to temporarily detain oil or other floatable pollutants before they enter the downstream drainage system in the event of an accidental spill or illegal dumping. It may consist of a tee section in a manhole or catch basin, or another alternative as specified in Section 4.2.1.1 Spill Control.

²⁰ *Natural onsite drainage feature* means a natural swale, channel, stream, closed depression, wetland, or lake.

The spill control device should be installed upstream of any onsite water quality or flow control facility. Note that in addition to this spill control requirement to protect offsite and natural drainage systems, there are other spill control requirements in this manual for discharges to certain water quality facilities and all infiltration facilities (see the design criteria for water quality facilities in Chapter 6 and the general requirements for infiltration facilities in Section 5.2). The application of these requirements must be such that all stated intents are satisfied. If no facilities are present, then the spill control device must be installed upstream from the final discharge point to the downstream drainage system.

Composition

Where feasible, conveyance systems shall be constructed of vegetation-lined channels, as opposed to pipe systems. Vegetative channels shall generally be considered feasible if all of these conditions are present:

1. The channel gradient generally does not exceed five percent, AND
2. No modifications to currently adopted standard roadway cross-sections in the *Kent Design and Construction Standards* are necessitated by the channel, AND
3. The channel will be accessible for maintenance (see Section 1.2.6), AND
4. The channel will not be subject to erosion.

Exceptions: The following are exceptions to the requirement for vegetative channels:

- Conveyance systems proposed under roadways, driveways, or parking areas
- Conveyance systems proposed between houses in urban-zoned plats and short plats
- Conveyance systems conveying roof runoff only.

Outfalls

An outfall is defined as a point where collected and concentrated surface and stormwater runoff is discharged from a pipe system or culvert.

Energy Dissipation: At a minimum, rock erosion protection is required at outfalls from all drainage systems and elements except where city review staff determines that erosion protection is being provided by other means or is not needed. Details on outfall structures are included in Section 4.2.2.

New Point Discharges Over Steep Slopes / Landslide Hazard Areas: Proposed outfalls that will discharge runoff in a location where the natural (existing) discharge is unconcentrated over a slope steeper than 15% and greater than 20 feet in height, or discharge runoff through a designated *steep slope hazard area* must meet the following criteria:

1. A tightline conveyance system must be constructed to convey the runoff to the bottom of the slope unless other measures are approved by city review staff based on an evaluation/report by a licensed geotechnical engineer.
2. The geotechnical analysis must consider cumulative impacts from the project and surrounding areas under full built-out conditions.
3. Tightline systems must be designed so that existing baseflow conditions are not significantly changed and adequate energy dissipation is provided at the bottom of the slope.
4. Where alternative measures (e.g., dispersal trench) to the tightline system are approved upstream of a *landslide hazard area* or *steep slope hazard area*, they may be placed no closer than 50 feet from the top of the hazard area slope based on an evaluation/report by a licensed geotechnical engineer.

Outfalls to the Green River

New stormwater outfalls or modifications to existing stormwater outfalls discharging to the Green River are **allowed only through the adjustment process**. These outfalls must comply with requirements of the *Green River Pump Operations Procedure Plan*, which establishes storage volumes and release rate criteria for developments proposing to **construct or modify** outfalls. Copies of the plan are available from the city of Kent.

Interflow and Interception

Interflow is near-surface groundwater that moves laterally through the soil horizon following the hydraulic gradient of underlying relatively impermeable soils. When interflow is expressed on the surface, it is termed a *spring or seepage*. Any significant springs or seepage areas that impact a roadway or structure proposed by the project must be intercepted and directed into a conveyance system. Where roadways may impede the passage of interflow to downstream wetlands or streams, provision for passage of unconcentrated flows must be made.

Pump Systems

Pump systems may be used to convey water from one location or elevation to another within the **project site** provided they meet the design criteria specified for such systems in Section 4.2.3 and will be privately owned and maintained.

Pump systems that discharge flows from the **project site** that would not have discharged by gravity flow under **existing site conditions** will require an approved adjustment to Core Requirement #1 (see Section 1.4, “Adjustment Process”). These pump systems will be considered only when they are necessary to prevent creation or aggravation of a flooding or erosion problem as specified in Section 1.2.2. Pump systems discharging to the Green River must also comply with the *Green River Pump Operations Procedure Plan*.

1.2.5 CORE REQUIREMENT #5: EROSION AND SEDIMENT CONTROL

R
E
Q

All proposed projects that will clear, grade, or otherwise disturb the **site** must provide erosion and sediment controls to prevent, to the maximum extent possible, the transport of sediment from the **project site** to downstream drainage facilities, water resources, and adjacent properties. All proposed projects that will conduct construction activities onsite or offsite must provide stormwater pollution prevention and spill controls to prevent, reduce, or eliminate the discharge of pollutants to onsite or adjacent stormwater systems or watercourses. To prevent sediment transport, **Erosion and Sediment Control (ESC)** measures and **Stormwater Pollution Prevention and Spill Control (SWPPS)** measures that are appropriate to the **project site** must be applied through a comprehensive **Construction Stormwater Pollution Prevention (CSWPP) plan** as described in Sections 1.2.5.1 and 1.2.5.3 and shall perform as described in Section 1.2.5.2. In addition, these measures, both temporary and permanent, shall be implemented consistent with the requirements in Section 1.2.5.3 that apply to the proposed project.

Intent:

- To prevent the transport of sediment and other impacts, like increased runoff, related to land disturbing activities. Erosion of disturbed areas on construction sites can result in excessive sediment transport to adjacent properties and to surface waters. This sediment can result in major adverse impacts, such as flooding from obstructed drainage ways, smothering of salmonid spawning beds, algal blooms in lakes, and exceedances of state water quality standards for turbidity. These impacts can also result from the increased runoff generated by land disturbing activities on construction sites.
- To prevent, reduce, or eliminate the discharge of pollutants to onsite or adjacent stormwater systems or watercourses from construction-related activities such as materials delivery and storage, onsite equipment fueling and maintenance, demolition of existing buildings and disposition of demolition materials and other waste, and concrete handling, washout and disposal.

1.2.5.1 CSWPP MEASURES

Construction Stormwater Pollution Prevention (CSWPP) measures include Erosion and Sediment Control (ESC) measures and Stormwater Pollution Prevention and Spill (SWPPS) measures.

The following ESC measures shall be provided as specified below and as further detailed in the *Erosion and Sediment Control (ESC) Standards*, adopted as Appendix D:

1. **Clearing Limits:** Prior to any *site* clearing or grading, areas to remain undisturbed during project construction shall be delineated. At a minimum, clearing limit delineation flagging shall be provided at the edges of all stream, lake, or wetland buffers.
2. **Cover Measures:** Temporary and permanent cover measures shall be provided when necessary to protect disturbed areas. Temporary cover shall be installed if an area is to remain unworked for more than seven days during the dry season (May 1 to September 30) or for more than two days during the wet season (October 1 to April 30), unless otherwise determined by the City. Any area to remain unworked for more than 30 days shall be seeded or sodded, unless the City determines that winter weather makes vegetation establishment unfeasible. **During the wet season, slopes and stockpiles 3H:1V or steeper with more than 10 feet of vertical relief shall be covered if they are to remain unworked for more than 12 hours.** The intent of these measures is to prevent erosion by having as much area as possible covered during any period of precipitation.
3. **Perimeter Protection:** When necessary, perimeter protection to filter sediment from sheet flow shall be provided downstream of all disturbed areas. Perimeter protection includes the use of vegetated strips, as well as more conventional constructed measures such as silt fences. Such protection shall be installed prior to upstream grading.
4. **Traffic Area Stabilization:** Unsurfaced entrances, roads, and parking areas used by construction traffic shall be stabilized to minimize erosion and tracking of sediment offsite.
5. **Sediment Retention:** Surface water collected from disturbed areas of the site shall be routed through a sediment pond or trap prior to release from the *site*. This does not apply to areas at the perimeter of the *site* small enough to be treated solely with perimeter protection. Sediment retention facilities shall be installed prior to grading any contributing area.
6. **Surface Water Controls:** Surface water controls shall be installed to intercept all surface water from disturbed areas, convey it to a sediment pond or trap, and discharge it downstream of any disturbed areas. However, areas at the perimeter of the *site* small enough to be treated solely with perimeter protection do not require surface water controls. Significant sources of upstream surface water that drain onto disturbed areas shall be intercepted and conveyed to a stabilized discharge point downstream of the disturbed areas. Surface water controls shall be installed concurrently with or immediately following rough grading.
7. **Dust Control:** Preventative measures to minimize wind transport of soil shall be implemented when a traffic hazard may be created or when sediment transported by wind is likely to be deposited in water resources.
8. **Dewatering Control:** The water resulting from construction site de-watering activities must be treated prior to discharge or disposed of as specified.
9. **Flow Control:** Surface water from disturbed areas must be routed through the project's onsite flow control facility or other provisions must be made to prevent increases in the existing site conditions 2- year and 10-year runoff peaks discharging from the project site during construction (flow control BMP areas (existing or proposed) shall not be used for this purpose).
10. **Control Pollutants:** Stormwater pollution prevention (SWPPS) measures are required to prevent, reduce, or eliminate the discharge of pollutants to onsite or adjacent stormwater systems or watercourses from construction-related activities such as materials delivery and storage, onsite

equipment fueling and maintenance, demolition of existing buildings and disposition of demolition materials and other waste, and concrete handling, washout and disposal. Section D.2.2 describes BMPs specific to this purpose; additionally, several of the ESC BMPs described herein are applicable.

11. **Protect Existing and Proposed Flow Control BMPs:** Sedimentation and soil compaction reduce the infiltration capacity of native and engineered soils. Protection measures shall be applied/installed and maintained so as to prevent adverse impacts to existing flow control BMPs and areas of proposed flow control BMPs for the project. Adverse impacts can prompt the requirement to restore or replace affected BMPs.
12. **Maintain BMPs:** Protection measures shall be maintained to assure continued performance of their intended function, to prevent adverse impacts to existing flow control BMPs and areas of proposed flow control BMPs, and protect other disturbed areas of the project.
13. **Manage the Project:** Coordination and timing of site development activities relative to ESC concerns, and timely inspection, maintenance and update of protective measures are necessary to effectively manage the project and assure the success of protective ESC and SWPPS design and implementation.

SWPPS MEASURES

Each of the following categories of SWPPS measures must be considered for application to the *project site* as detailed in the *Stormwater Pollution Prevention and Spill Control (SWPPS) Standards*. The SWPPS standards are located in the *Construction Stormwater Pollution Prevention Standards* adopted as Appendix D of this manual:

- Follow effective pollutant handling and disposal procedures.
- Provide cover and containment for materials, fuel and other pollutants.
- Manage the project site to maximize pollutant control and minimize pollutant sources.
- Protect from spills and drips of petroleum products and other pollutants.
- Avoid over application or untimely application of chemicals and fertilizers.
- Prevent or treat contamination of stormwater runoff by pH modifying sources.

1.2.5.2 CSWPP PERFORMANCE AND COMPLIANCE PROVISIONS

The changing conditions typical of construction sites call for frequent field adjustments of existing ESC and SWPPS measures or additional ESC and SWPPS measures in order to meet required performance. In some cases, strict adherence to specified measures may not be necessary or practicable based on *site* conditions or project type. In other cases, immediate action may be needed to avoid severe impacts. Therefore, careful attention must be paid to ESC and SWPPS performance and compliance in accordance with the following provisions:

A. CSWPP Supervisor

For projects in Targeted or Full Project Drainage Review, or projects in Directed Drainage Review as determined by city review staff, the **applicant must designate a CSWPP supervisor** who shall be responsible for the performance, maintenance, and review of ESC and SWPPS measures and for compliance with all permit conditions relating to CSWPP as described in the *CSWPP Standards*. For projects that disturb one acre or more of land, the CSWPP supervisor must be a **Certified**

Professional in Erosion and Sediment Control (see www.cpesc.net for more information) or a **Certified Erosion and Sediment Control Lead** whose certification is recognized by the City. The City may also require a certified ESC professional for sites smaller than one acre of disturbance if the City determines that onsite ESC measures are inadequately installed, located, or maintained.

For larger, more sensitive sites, the City may require a certified ESC professional with several years of experience in construction supervision/inspection and a background in geology, soil science, or agronomy (See Appendix D, Section D.2.3.1 for more information).

B. Monitoring Performance

The CSWPP supervisor shall have a turbidity meter onsite and shall use it to monitor surface and storm water discharges from the *project site* and into onsite wetlands, streams, or lakes whenever runoff occurs from onsite activities and during storm events. If the *project site* is subject to a NPDES general permit for construction issued by the Washington State Department of Ecology (*Ecology*), then the project must comply with the monitoring requirements of that permit.

The CSWPP supervisor shall also use the specific SWPPS control BMP procedures for monitoring surface and stormwater discharge for pollutants and acceptable discharge levels. The CSWPP supervisor shall keep logs as required by the procedures of all measurements taken onsite and make them available to the City on request.

C. ESC Performance

The above ESC measures shall be applied/installed and maintained so as to prevent, to the maximum extent possible, the transport of sediment from the *project site* to downstream drainage systems or surface waters or into onsite wetlands, streams, or lakes. This performance is intended to be achieved through proper selection, installation, and operation of the above ESC measures as detailed in the *CSWPP Standards* (detached Appendix D) and approved by the City. However, the City may determine at any time during construction that such approved measures are not sufficient and additional action is required based on one of the following criteria:

1. IF a turbidity test of surface and storm water discharges leaving the *project site* is greater than the benchmark value of 25 NTU (nephelometric turbidity units) set by the Washington State Department of Ecology, but less than 250 NTU, the CSWPP Supervisor shall do all of the following:
 - a) Review the ESC plan for compliance and make appropriate revisions within 7 days of the discharge that exceeded the benchmark of 25 NTU, AND
 - b) Fully implement and maintain appropriate ESC measures as soon as possible, AND
 - c) Document ESC implementation and maintenance in the *site* log book.
2. IF a turbidity test of surface or storm water discharging to wetlands, streams, or lakes indicates a turbidity level greater than 5 NTU above background when the background turbidity is 50 NTU or less, or 10% above background when the background turbidity is greater than 50 NTU, then corrective actions and/or additional measures beyond those specified in Section 1.2.5.1 shall be implemented as deemed necessary by the City inspector or onsite CSWPP supervisor.
3. IF discharge turbidity is 250 NTU or greater, the CSWPP Supervisor shall do all of the following:
 - a) Notify the City by telephone, AND

Notify the WA State Department of Ecology as required by NPDES Construction Stormwater General Permit, as applicable, AND

- b) Review the ESC plan for compliance and make appropriate revisions within 7 days of the discharge that exceeded the benchmark of 25 NTU, AND
 - c) Fully implement and maintain appropriate ESC measures as soon as possible but no later than 10 days after the discharge that exceeded the benchmark, AND
 - d) Document ESC implementation and maintenance in the *site* log book. AND
 - e) Continue to sample discharges until turbidity is 25 NTU or lower, or the turbidity is no more than 10% over background turbidity.
4. IF the City determines that the condition of the construction site poses a **hazard to adjacent property** or may **adversely impact drainage facilities or water resources**, THEN additional measures beyond those specified in Section 1.2.5.1 may be required by the City.

D. SWPPS Performance

SWPPS measures shall be applied/installed and maintained so as to prevent, reduce, or eliminate the discharge of pollutants to onsite or adjacent stormwater systems or watercourses or onto adjacent properties. This performance is intended to be achieved through proper selection, installation, and operation of the above SWPPS measures as detailed in the *CSWPP Standards* (detached Appendix D) and approved by the City. However, the CSWPP supervisor designated per Section 1.2.5.2.A or the City may determine at any time during construction that such approved measures are not sufficient and additional action is required based on the criteria described in the specific SWPPS BMP standard and/or conditions of an approved adjustment:

E. Flexible Compliance

Some projects may meet the intent of Core Requirement #5 while varying from specific CSWPP requirements contained here and in the *CSWPP Standards*. If a project is designed and constructed such that it meets the intent of this core requirement, the City may determine that strict adherence to a specific ESC requirement is unnecessary; an approved adjustment (see Section 1.4) is not required in these circumstances. Certain types of projects are particularly suited to warrant this greater level of flexibility; for instance, projects on relatively flat, well drained soils, projects that are constructed in closed depressions, or projects that only disturb a small percentage of a forested site may meet the intent of this requirement with very few ESC measures. However, SWPPS requirements may actually be emphasized on well-drained soils, particularly in groundwater or well-protection protection areas, or in close proximity to water bodies. More information on intent and general ESC principles is contained in the *ESC Standards*.

F. Roads and Utilities

Road and utility projects often pose difficult erosion control challenges because they frequently cross surface waters and are long and narrow with limited area available to treat and store sediment-laden water. Because of these factors, road and utility projects are allowed greater flexibility in meeting the intent of Core Requirement #5 as described in the *CSWPP Standards*. Projects that pose a very low risk of erosion or sediment transport due to site conditions or project scope may also warrant greater flexibility.

G. Alternative and Experimental Measures

All measures proposed for erosion and sediment control shall conform to the details and specifications in the *CSWPP Standards* unless an alternative is approved by the City, and if the

alternative is a new technology, it must also be approved through Ecology's CTAPE program (see "Alternative and Experimental Measures" in the *CSWPP Standards*, detached Appendix D).

1.2.5.3 CSWPP IMPLEMENTATION REQUIREMENTS

Proposed projects must identify, install, and maintain required erosion and sediment control and stormwater pollution prevention and spill control measures consistent with the following requirements:

A. CSWPP Plan

As specified in Chapter 2, all proposed projects must submit a **CSWPP plan** for implementing CSWPP measures. The CSWPP plan is comprised of the **ESC plan and the SWPPS plan**. The **ESC plan** must show the location and details of all ESC measures as specified in Chapter 2 and the *CSWPP Standards* and shall include a **CSWPP report**, which contains additional directions and supporting information like a detailed construction sequence as proposed by the design engineer and any calculations or information necessary to size ESC measures and demonstrate compliance with Core Requirement #5. The CSWPP plan shall also contain plan notes that outline specific permit conditions as outlined in Appendix D Section D.4.2 Standard ESC and SWPPS Plan Notes. The City may require large, complex projects to phase construction and to submit multiple ESC plans for the different stages of construction. New CSWPP plans are not required for changes that are necessary during construction, unless required by the City inspector.

B. Wet Season Construction

During the wet season (October 1 to April 30), any *site* with exposed soils shall be subject to the "Wet Season Requirements" contained in the *ESC Standards*. In addition to the ESC cover measures; these provisions include covering any newly seeded areas with mulch and seeding as much disturbed area as possible during the first week of October to provide grass cover for the wet season. Other ESC measures such as portable detention tanks and portable sand filters may be required for use during the wet season.

C. Construction within Streams, Lakes, or Wetlands and Buffers

Any construction that will result in disturbed areas on or within a stream or associated buffer, within a wetland or associated buffer, or within 50 feet of a lake shall be subject to the Kent city code section 11.06 "Critical Areas" as well as the "Critical Area Restrictions" contained in the *CSWPP Standards*. These provisions include phasing the project whenever possible so that construction in these areas is limited to the dry season.

D. Maintenance

All ESC and SWPPS measures shall be maintained and reviewed on a regular basis as prescribed in the *CSWPP Standards*.

E. Final Stabilization

Prior to obtaining final construction approval, the *site* shall be stabilized, structural ESC and SWPPS measures (such as silt fences, sediment traps, and concrete waste collection pits) shall be removed, and drainage facilities shall be cleaned as specified in the *CSWPP Standards*. A separate ESC plan describing final stabilization may be required by the City prior to implementation.

F. Consideration of Other Required Permits

Consideration should be given to the requirements and conditions that may be applied by other agencies as part of other permits required for land-disturbing activities. In particular, the following permits may be required and should be considered when implementing CSWPP measures:

- A **NPDES General Permit for Construction** (pursuant to the Washington State Department of Ecology's Construction General Permit for Stormwater) is required for projects that will disturb one or more acres for purposes of constructing or allowing for construction of a development, or projects disturbing less than one acre that are part of a larger common plan of sale²¹ that will ultimately disturb one or more acres.

²¹ ***Common plan of development or sale*** means a site where multiple separate and distinct construction activities may take place at different times or on different schedules, but still under a single plan. Examples include: 1) phased projects and projects with multiple filings or lots, even if the separate phases or filings/lots will be constructed under separate contract or by separate owners (e.g. a development where lots are sold to separate builders); 2) a development plan that may be phased over multiple years, but is still under a consistent plan for long-term development; and 3) projects in a contiguous area that may be unrelated but still under the same contract, such as construction of a building extension and a new parking lot at the same facility.

1.2.6 CORE REQUIREMENT #6: MAINTENANCE AND OPERATIONS

R
E
Q

Maintenance and operation of all drainage facilities is the responsibility of the applicant or property owner, except those facilities for which Kent is granted an easement, tract, or right-of-way and officially assumes maintenance and operation as described below.

Intent: To ensure that the maintenance responsibility for drainage facilities is clearly assigned and that these facilities will be properly maintained and operated in perpetuity.

Drainage Facilities to be Maintained by the City of Kent

Kent will assume maintenance and operation²² of conveyance systems within improved public road rights-of-way and flow control and water quality facilities if these systems/facilities are associated with a residential subdivision with ten or more lots served by a public street, or a non-residential short plat or long plat subdivision (i.e., commercial, industrial, etc.). Kent will not assume maintenance and operation of stormwater facilities associated with residential subdivisions with 9 or less lots served by a private street or stormwater facilities associated with commercial or industrial developments located on single parcels.

Kent will not assume maintenance responsibility for underground detention vaults except as described in section 1.2.3, Core Requirement #3.

Kent **will assume maintenance** and operation of these facilities **two years after final construction approval** by the Public Works and Economic and Community Development departments and an inspection by the City to ensure the facilities have been properly maintained and are operating as designed.

Flow control and water quality facilities and **flow control BMP devices** to be maintained and operated by Kent must be located in a tract or right-of-way dedicated to Kent. Required vegetated flow paths for full dispersion and basic dispersion BMPs require a recorded declaration of covenant that stipulates restrictions on use AND shall be located in an easement that includes provisions for access and maintenance. City of Kent maintenance of these vegetated flow paths will be limited to their FCBMP functionality. All other maintenance shall remain the responsibility of the owner(s). Access roads serving these facilities must also be located in the tract or right-of-way and must be connected to an improved public road right-of-way.

Conveyance systems to be maintained and operated by Kent must be located in a drainage easement, tract, or right-of-way granted to Kent. *Note: Kent does not normally assume maintenance responsibility for conveyance systems which are outside of improved public road right-of-way.*

Exceptions to the above will be made on a case-by-case basis as determined by the Director.

Drainage Facilities to be Maintained by Private Parties

All privately maintained drainage facilities must be maintained as specified in Appendix A, “Maintenance Requirements for Flow Control, Conveyance, and WQ Facilities,” and as further prescribed in **Chapter 6** for water quality facilities unless otherwise approved by city review staff. A copy of the **Operation and Maintenance Manual** submitted as part of the permit application (see Section 2.3.1) shall be retained on

²² Kent does not assume maintenance of lot drainage systems or drainage stub-outs serving single-family residential lot downspout, footing, or yard drains, nor does Kent assume maintenance of those water quality facilities installed and integrated into site landscaping.

site and shall be transferred with the property to the new owner. A log of maintenance activity indicating when cleaning occurred and where waste was disposed of shall also be kept by the owner and be available for inspection by the City.

All privately maintained **flow control BMPs** must be maintained as specified in the *site/lot's* declaration of covenant and grant of easement per Section 1.2.9.

A “Declaration of Stormwater Facility Maintenance Covenant” must be completed for all private developments. Stormwater covenant to be obtained on COK website or from plan review staff.. The timing of completion of this agreement varies depending on the type of development. For stormwater facilities serving more than one single family residential unit in a short plat serving less than four lots, the agreement shall be completed prior to plat recording. For all other developments or redevelopments (including commercial, industrial, multifamily development or redevelopment or single family residential building), the agreement shall be completed prior to engineering plan approval. If there is a shared drainage system involved with the development, the covenant must provide clear language on the ownership and maintenance responsibilities of each component of the drainage system. The responsibilities detailed in the document may be assumed by a homeowners association or other legal organization as approved by the City of Kent.

Whenever a flow control or water quality facility or flow control BMP is proposed to be located on a parcel separate from the parcel or parcels containing the target surfaces mitigated by the facility or BMP, provisions must be made to ensure that the owner or owners of the target surfaces have a perpetual right to operate and maintain the facility. This may be done either by recording an easement granting this right to the owner(s) of the target surfaces, or by conveying the land on which the facility sits (or an interest therein) to the owner(s) of target surfaces.

Kent may inspect all privately maintained drainage facilities for compliance with these requirements. If property owner(s) fail to maintain their facilities to acceptable standards, the City may issue a written notice specifying the required remedial actions and requiring a schedule for timely completion of the actions. If these actions are not performed in a timely manner, the City may enter the property to perform the actions needed and bill the property owner(s) for the cost of the actions. In the event a hazard to public safety exists, the City may perform remedial actions without written notice.

If the proposed project is a **residential subdivision development**, all privately maintained conveyance systems or other drainage facilities, which convey flows through private property, must be located in a **drainage easement dedicated to convey surface and stormwater**. Individual owners of the properties containing such easements must maintain the drainage facilities through their property. The legal instrument creating drainage easements on private property must contain language that requires a private property owner to obtain written approval from Kent prior to removing vegetation (except by routine mowing) from any drainage easement containing open, vegetated drainage facilities (such as swales, channels, ditches, ponds, etc.). A sample copy of the City of Kent’s Drainage Easement is included with the Manual as Reference 8-G.

1.2.7 CORE REQUIREMENT #7: FINANCIAL GUARANTEES AND LIABILITY

R
E
Q

All drainage facilities constructed or modified for projects (except downspout infiltration and dispersion systems), and any work performed in the right-of-way, must comply with City of Kent's financial guarantee requirements.

Intent: To ensure financial guarantees are posted to sufficiently cover the cost of correcting, if necessary, incomplete or substandard drainage facility construction work, and to warrant for one year the satisfactory performance and maintenance of those newly-constructed drainage facilities to be assumed by Kent for maintenance and operation. Core Requirement #7 is also intended to ensure that a liability policy is provided that protects the proponent and the City from any damages relating to the construction or maintenance of required drainage facilities by private parties.

Surface Water and Drainage Facilities Construction Bond

Prior to commencing construction, applicants that are required to construct drainage facilities pursuant to this manual and/or any other requirements of the Kent City Code must post a Surface Water and Drainage Facilities Construction Bond (see Reference 8-E). This guarantee must be an amount sufficient to cover the cost of project-related work performed on- or off-*site*. The exact amount of the bond shall be documented in the approved engineers estimate. *Note: City review staff may waive the requirement of this guarantee on projects proposing only minor modifications or improvements to the drainage system (e.g., catch basin inserts, spill control devices, pipe replacements, etc.). In addition, this guarantee may be combined with other required guarantees.*

The bond shall be released in two stages as follows. Generally, 80% of the bond is released upon completion of the following:

1. Payment of all required fees.
2. Construction of the drainage facilities.
3. Receipt of final construction approval from city review staff.
4. Provide the City with As-builts meeting the requirements of the City of Kent Construction Standards (including this manual).

The drainage facilities shall be maintained during a period of two years according to the City of Kent's "Maintenance Requirements for Privately Maintained Drainage Facilities." At the end of the year, the remaining 10% of the bond is released subject to the following requirements:

1. For plats, record the final plat.
2. For tracts containing drainage facilities to be maintained by Kent and not located within the final plat, deed the tract to Kent and set property corners in conformance with state surveying standards.
3. For easements containing drainage facilities to be maintained by Kent and not located within the final plat, provide easement documents and set temporary survey markers to delineate the easement location.
4. Receive a final City inspection to ensure the drainage facilities have been properly maintained and are operating as designed.
5. Correct any defects noted in the final inspection.
6. Submit a letter to the City formally requesting a release of the bond.

Following completion of these steps, the City will assume maintenance and operation of the drainage facilities.

1.2.8 CORE REQUIREMENT #8: WATER QUALITY

R
E
Q All proposed projects, including *redevelopment projects*, must provide water quality (WQ) facilities to treat the runoff from those new and replaced *pollution-generating impervious surfaces* and new *pollution-generating pervious surfaces* targeted for treatment as specified in the following sections. These facilities shall be selected from one of the area-specific WQ menus described in Section 1.2.8.1 and implemented according to the applicable WQ implementation requirements in Section 1.2.8.2.

Intent: To require an efficient, cost-effective level of water quality treatment tailored to the sensitivities and resource protection needs of the downstream receiving water to which the *project site* drains, or, in the case of infiltration, protection of the receiving groundwater system.

Guide to Applying Core Requirement #8

Core Requirement #8 requires that WQ treatment facilities be provided to remove pollutants from runoff discharging from the *project site* in accordance with water quality facility requirements menu found in Section 1.2.8.1.

The WQ menus are a group of facility options designed to provide levels of treatment targeted to resource protection needs.

WQ implementation requirements are the minimum requirements for analyzing and designing WQ facilities to achieve intended performance and other protection goals.

Other Important Information about Core Requirement #8

Core Requirement #8 is the primary component of an overall water quality protection strategy required by this manual. Other requirements include the following:

- Core Requirement #4: **Conveyance System, Spill Control Provisions**, Section 1.2.4—This provision generally applies whenever a project constructs or replaces onsite conveyance system elements that receive runoff from *pollution-generating impervious surfaces*. The provision requires that runoff from such impervious surfaces be routed through a spill control device prior to discharge from the *project site* or into a natural onsite drainage feature.
- Core Requirement #4: **Conveyance System, Groundwater Protection**, Section 1.2.4 — This provision requires that ditches/channels be lined as needed to reduce the risk of groundwater contamination when they convey runoff from *pollution-generating impervious surfaces* that comes into direct contact with an outwash soil.
- Special Requirement #4: **Source Control**, Section 1.3.4—This requirement applies water quality source controls from the *King County Stormwater Pollution Prevention Manual* to those projects proposing to commercial, industrial, and multifamily projects.
- Special Requirement #5: **Oil Control**, Section 1.3.5—This requirement applies special oil controls to those projects proposing to develop or redevelop a *high-use site*.

❑ EXEMPTIONS FROM CORE REQUIREMENT #8

There are four possible exemptions from the requirement to provide a **formal water quality facility** per Core Requirement #8:

1. Surface Area Exemption

A proposed non-redevelopment project or any *threshold discharge area* within the *site* of such a project is exempt if it meets all of the following criteria:

- a) Less than 5,000 square feet of *new plus replaced PGIS* will be created, AND
- b) Less than $\frac{3}{4}$ acre of *new PGPS* will be added.

2. Surface Exemption for Transportation Redevelopment Projects

A proposed *transportation redevelopment project* or any *threshold discharge area* within the *site* of such a project is exempt if it meets all of the following criteria:

- a) The **total new impervious surface** within the project limits is less than 50% of the existing impervious surface, AND
- b) Less than 5,000 square feet of *new PGIS* will be added, AND
- c) Less than $\frac{3}{4}$ acre of *new PGPS* will be added.

3. Cost Exemption for Parcel Redevelopment Projects

A proposed *redevelopment project* on a single or multiple parcel *site* or any *threshold discharge area* within the *site* of such a project is exempt if it meets all of the following criteria:

- a) The **total valuation** of the project's proposed improvements (including interior improvements and excluding required mitigation improvements) is less than 50% of the assessed value of (a) the existing project site improvements on commercial or industrial projects, or (b) the existing site improvements on other projects, AND
- b) Less than 5,000 square feet of *new PGIS* will be added, AND
- c) Less than $\frac{3}{4}$ acre of *new PGPS* will be added.

4. Soil Treatment Exemption

A proposed project or any drainage area within a project is exempt:

- If the runoff from *pollution-generating impervious and pollution-generating pervious surfaces* is infiltrated in a facility per Section 5.2.1 in soils that meet the groundwater protection soil quality, depth, and infiltration rate criteria given in Section 5.2.1. This exemption is not allowed for areas that are infiltrated (1) within one quarter mile of a sensitive lake²³, or (2) within one quarter mile of fresh water with existing or designated aquatic life use whose land use would otherwise trigger application of a facility from enhanced basic treatment menu, or (3) within one quarter mile of a phosphorus or metals problem as described in section 1.2.2.1.2.

1.2.8.1 AREA-SPECIFIC WATER QUALITY FACILITY REQUIREMENT

Projects subject to Core Requirement #8 must provide a water quality facility selected from a menu of water quality facility options identified in the area-specific facility requirements and exceptions for the WQ treatment area in which the proposed project or *threshold discharge area* of the proposed project is

²³ Sensitive Lake is a designation applied by the City to lakes that are particularly prone to eutrophication from development-induced increases in phosphorus loading. Such lakes are identified on the Water Quality Applications Map adopted with this manual.

located. These WQ treatment areas are listed below, and their requirements and exceptions are detailed in the following subsections:

- A. Basic WQ Treatment Areas
- B. Enhanced Basic WQ Treatment Areas
- C. Sensitive Lake WQ Treatment Areas

Intent: The City of Kent contains numerous sensitive and significant water resources. The City has determined that the minimum level of treatment adequate to prevent further degradation of water quality, and to maintain the aquatic health of current fisheries, is that provided by the Enhanced Basic Water Quality Treatment Areas Menu. The Director has the option to require additional treatment, or treatment of existing impervious areas, when necessary to meet water quality standards and goals (see Reference 8-H).

❑ BASIC WQ TREATMENT AREAS

The Basic WQ Treatment Areas menu is applied where a general, cost-effective level of treatment is adequate and where more intensive, targeted pollutant removal is not needed to protect receiving bodies. In the City of Kent, the only acceptable use of the Basic WQ Treatment Areas menu is for *redevelopment projects* that are subject to Core Requirement #8 and where approved on a project-specific basis by the Director. Under no circumstances shall a level of treatment less than what currently exists on a redevelopment site be permitted. For example, if a site already has an enhanced-basic WQ facility, it cannot be replaced by a basic WQ facility.

Treatment Goals and Options

The treatment goal for facility options in the Basic WQ Treatment Areas menu is 80% removal of total suspended solids (TSS) for flows or volumes up to and including the WQ design flow or volume for a typical rainfall year, assuming typical pollutant concentrations in urban runoff²⁴. TSS is the general performance indicator for basic water quality protection because it is the most obvious pollutant of concern. TSS is not a single pollutant — it is a general term for a highly variable mixture of solid pollutants with variable particle size and particle density distributions, and to one degree or another containing a variety of sorbed dissolvable pollutants. The basic WQ Treatment Areas menu includes facilities such as wetponds, combined detention/wetponds, biofiltration swales, vegetated filter strips and sand filters. See Chapter 6 for specific facility options and designs.

Intent

The **Basic WQ menu** is intended to be applied to both stormwater discharges that drain to surface waters and those that infiltrate into soils that do not provide adequate groundwater protection (see Exemptions 3 and 4 from Core Requirement #8).

❑ ENHANCED BASIC WQ TREATMENT AREAS

The treatment goal for facility options in the **Enhanced Basic WQ menu** is to accomplish better

²⁴ The influent concentration range for demonstrated pollutant removal is 100 to 200 mg/L. For influent concentrations lower than 100mg/l the effluent goal is equal to or less than 20 mg/l. For influent concentrations greater than 200 mg/l, the goal is greater than 80% TSS removal.

removal of heavy metals and potentially other toxic materials than can be achieved by basic treatment, while still meeting the basic treatment goal of 80% TSS removal. The specific target performance is > 30% reduction of dissolved copper and > 60% removal of dissolved zinc. Dissolved copper and zinc are indicators of a wider range of metals typically found in urban runoff that are potentially toxic to fish and other aquatic life. The Enhanced Basic WQ menu includes options for use of a basic-sized stormwater wetland, a large sand filter, or a combination of two facilities in series. See Chapter 6 for specific facility options and designs. Additional facility designs may appear in Reference 14 in the future.

Intent

Facility options in the **Enhanced Basic WQ menu** are intended to remove more metals than expected from those in the Basic WQ menu. Lower metal concentrations reduce the risk to fish from exposure to both chronic and acute toxic concentrations of metals such as copper and zinc, and very low concentration copper deleterious olfactory effects. As the toxicity of metals depends on their concentration, this standard is most effective for *project sites* with a larger proportion of *pollution-generating impervious surface* like roadways and medium to high density subdivisions. The Enhanced Basic WQ menu is intended to apply to all such areas in Kent unless otherwise denoted on the Water Quality Applications Map.

Target Surfaces

Facilities in **Enhanced Basic WQ Treatment Areas** must treat (either directly or in effect) the runoff from the following target surfaces within the *threshold discharge area* for which the facility is required:

1. **New PGIS** that is **not fully dispersed** per the Criteria for Fully Dispersed Surfaces in Core Requirement #3, or **not farmland dispersed** as specified in Appendix C. For individual lots within residential subdivision projects, the extent of **new PGIS** shall be assumed based on expected driveway size as approved by city review staff.
2. **New PGPS** that is **not fully dispersed** and from which there will be a concentrated surface discharge in a natural channel or man-made conveyance system from the *site*, or **not farmland dispersed** as specified in Appendix C. For individual lots within residential subdivision projects, the extent of **new pervious surface** shall be assumed to be the entire lot area, except the assumed impervious portion as specified in Chapter 3 and any portion in which native conditions are preserved by covenant, tract, or easement.
3. **Existing impervious surface** added since January 8, 2001 that is **not fully dispersed**, or **not farmland dispersed** as specified in Appendix C, and not yet mitigated with a City-approved water quality facility or flow control BMP. *Note: January 8, 2001 is the effective date of the ESA 4(d) Rule for Puget Sound Chinook salmon.*
4. **Replaced PGIS** that is **not fully dispersed** or **not farmland dispersed** as specified in Appendix C on a non-redevelopment project.
5. **Replaced PGIS** that is **not fully dispersed** on a **transportation redevelopment project** in which **new impervious surface** is 5,000 square feet or more and totals 50% or more of the existing impervious surface within the project limits.
6. **Replaced PGIS** that is **not fully dispersed**, or **not farmland dispersed** as specified in Appendix C, on a **parcel redevelopment project** in which the total of new plus **replaced impervious surface** is 5,000 square feet or more and whose valuation of proposed improvements (including interior improvements and excluding required mitigation improvements) exceeds 50% of the assessed value of: (a) the existing site improvements on commercial or industrial projects or (b) the existing site improvements on other projects, whichever applies.

Exceptions

The following exceptions apply only in **Enhanced Basic WQ Treatment Areas**:

1. The facility requirement in **Enhanced Basic WQ Treatment Areas** as applied to **target PGPS** may be waived for projects where city review staff approves a *landscape management plan* (LMP) that controls solids, pesticides, fertilizers, and other erodible or leachable materials leaving the *site*.

LMP requirements can be found in Reference Section 4-C. LMP submittal requirements are given in Section 2.3.1.5.

2. The **Enhanced Basic WQ menu** may be reduced to the **Basic WQ menu** for treatment of any runoff that is infiltrated per the standards of Section 5.2. This exception is not allowed where infiltrating into soils that do not meet the groundwater protection standards described in Section 5.2.1, if within one-quarter-mile of a fresh water designated for aquatic life use or that has an existing aquatic life use.

❑ SENSITIVE LAKE PROTECTION MENU

Sensitive Lake WQ Treatment Areas are designated by Kent in the watersheds of lakes that have a combination of water quality characteristics and watershed development potential that makes them particularly prone to eutrophication induced by development. Such areas are delineated on the WQ Applications Map adopted with this manual.

The usage of cartridge filter facilities shall be restricted to sites where the water quality facility will be maintained by the private property owner; cartridge filters will not be allowed on sites where the City will be maintaining the water quality facility.

Note: For projects located at or near the delineated boundary of the Sensitive Lake WQ Treatment Area, **site-specific** topography or drainage information may be needed to verify that the project or any **threshold discharge area** of the project is within the WQ treatment area. Any **threshold discharge area** is considered to be within the Sensitive Lake WQ Treatment Area if the **threshold discharge area** drains to the sensitive lake itself or to any waterbody or drainage system that is clearly within the mapped Sensitive Lake WQ Treatment Area.

Required Treatment Menu

Within Sensitive Lake WQ Treatment Areas, a water quality facility option from the **Sensitive Lake Protection menu** shall be used to treat runoff from the surfaces listed under "Target Surfaces" below, except where such treatment is waived or reduced by the area-specific exceptions at the end of this subsection and except where the Enhanced Basic WQ menu is applicable as follows. If 50% or more of the runoff that drains to any proposed water quality facility is from one or more of the **following land uses**, then a water quality facility option common to both the **Sensitive Lake Protection menu and Enhanced Basic WQ menu** shall be used for the design of this facility, except if such treatment is waived or reduced by the area-specific exceptions at the end of this subsection:

1. Residential subdivision development in which the actual density of single family units is equal to or greater than 8 units per acre of developed area.
2. Commercial, industrial, or multifamily land use.
3. A road with an expected average daily traffic (ADT) count of 2,000 or more vehicles or expected to serve 200 or more homes.

Treatment Goal and Options

The treatment goal for facility options in the Sensitive Lake Protection menu is 50% annual average total phosphorus (TP) removal assuming typical pollutant concentrations in urban runoff.²⁵ This goal was chosen as a realistic and cost-effective level of phosphorus removal. The Sensitive Lake Protection menu includes options for using either Basic WQ facilities of larger size, combinations of two facilities in series,²⁶ or a single facility in combination with land use planning elements that reduce phosphorus. See Chapter 6 for specific facility options and design details.

On some developments or portions thereof that have surface uses that generate the highest concentrations of metals in stormwater runoff, the treatment goal is expanded to include > 30% reduction of dissolved copper and > 60% removal of dissolved zinc. This expanded goal requires use of a water quality facility option that is common to both the Sensitive Lake Protection menu and the Enhanced Basic menu.

Intent

A project discharging runoff via surface flow contributes phosphorus loading to a sensitive lake regardless of distance from the lake. If discharge is via infiltration through coarse soils, it is also possible that phosphorus would be transported through the ground for some distance without attenuation. This groundwater transport distance is considered to be typically no more than one-quarter mile. Therefore, onsite treatment using the **Sensitive Lake Protection menu** is required prior to infiltration within one-quarter mile of a sensitive lake. Infiltration through finer soils is expected to provide significant attenuation of TP, so the general groundwater protection criteria specified in Section 5.2.1 are considered sufficient to reduce the facility requirement from the Sensitive Lake Protection menu to the Basic WQ menu for infiltration through qualifying soils.

Where the treatment goal is expanded to include > 30% reduction of dissolved copper and > 60% removal of dissolved zinc, the facility options common to both the Sensitive Lake Protection menu and the Enhanced Basic WQ menu should meet this goal as well as the lake protection goal of 50% removal of annual average total phosphorus.

Target Surfaces

Facilities in **Sensitive Lake WQ Treatment Areas** must mitigate (either directly or in effect) the runoff from the following target surfaces within the *threshold discharge area* for which the facility is required:

1. **New PGIS** that is **not fully dispersed** per the Criteria for Fully Dispersed Surfaces in Core Requirement #3, or **not farmland dispersed** as specified in Appendix C. For individual lots within residential subdivision projects, the extent of **new PGIS** shall be assumed based on expected driveway size as approved by ECD.
2. **New PGPS** that is **not fully dispersed** and from which there will be a concentrated surface discharge in a natural channel or man-made conveyance system from the *site*, or **not farmland dispersed** as specified in Appendix C. For individual lots within residential subdivision projects, the extent of **new pervious surface** shall be assumed to be the entire lot area, except the assumed impervious portion as specified in Chapter 3 and any portion in which native conditions are preserved by covenant, tract, or easement. *Note: where the runoff from target PGPS is separated from the runoff from target PGIS, the*

²⁵ Phosphorus concentrations of between 0.10 and 0.50 mg/L are considered typical of Seattle area runoff (Table 1, "Water Quality Thresholds Decision paper," King County Surface Water Management Division, April 1994).

²⁶ *In series* means that the entire treatment water volume flows from one facility to the other in turn.

*Basic WQ menu may be used in place of the Sensitive Lake Protection menu for treatment of runoff from the **target PGPS** (see the area-specific exceptions at the end of this subsection).*

3. **Existing impervious surface** added since January 8, 2001 that is **not fully dispersed**, or **not farmland dispersed** as specified in Appendix C, and not yet mitigated with a City-approved water quality facility or flow control BMP. *Note: January 8, 2001 is the effective date of the ESA 4(d) Rule for Puget Sound Chinook salmon.*
4. **Replaced PGIS that is not fully dispersed**, or **not farmland dispersed** as specified in Appendix C, on a non-redevelopment project.
5. **Replaced PGIS that is not fully dispersed** on a **transportation redevelopment project** in which **new impervious surface** is 5,000 square feet or more and totals 50% or more of the existing impervious surface within the project limits.
6. **Replaced PGIS that is not fully dispersed**, or **not farmland dispersed** as specified in Appendix C, on a **parcel redevelopment project** in which the total of new plus **replaced impervious surface** is 5,000 square feet or more and whose valuation of proposed improvements (including interior improvements and excluding required mitigation improvements) exceeds 50% of the assessed value of: (a) the existing site improvements on commercial or industrial projects or (b) the existing site improvements on other projects, whichever applies.

Exceptions

The following exceptions apply only **in Sensitive Lake WQ Treatment Areas**:

1. The **Basic WQ menu** may be used in place of the **Sensitive Lake Protection menu** for treatment of **runoff that is infiltrated** according to the standards in Section 5.2. This exception is not allowed where infiltrating into soils that do not meet the groundwater protection standards described in Section 5.2.1, if within one-quarter-mile of a phosphorous sensitive receiving water or a tributary to that receiving water.
2. Application of the **Enhanced Basic WQ menu** as specified above for certain land uses may be waived for treatment of any runoff that is infiltrated according to the standards in Section 5.2 (A facility from the Sensitive Lake Protection menu is still required unless that requirement has been reduced to the Basic WQ menu by another exception). This exception is not allowed where infiltrating into soils that do not meet the groundwater protection standards described in Section 5.2.1, if within one-quarter-mile of a fresh water designated for aquatic life use or that has an existing aquatic life use.
3. Application of the **Enhanced Basic WQ menu** as specified above for certain land uses may be waived for treatment of any runoff that is discharged, via a non-fish-bearing conveyance system, all the way to the ordinary high water mark of a stream with a mean annual flow of 1,000 cfs or more (at the discharge point of the conveyance system) or a lake that is 300 acres or larger (A facility from the Sensitive Lake Protection menu is still required unless that requirement has been reduced to the Basic WQ menu by another exception). This exception is not applicable where the receiving water is impaired for metals per Section 1.2.2.1: Downstream Analysis, and 1.2.2.1.2: Downstream Water Quality Problems Requiring Special Attention, Metals Problem (Type 4).
4. The **Enhanced Basic WQ menu** as specified above for treating runoff from a commercial land use may be waived (A facility from the Sensitive Lake Protection menu is still required unless that requirement has been reduced to the Basic WQ menu by another exception) if all of the following criteria are met:

- a) No leachable metals (e.g., galvanized metals) are currently used or proposed to be used in areas of the *site* exposed to the weather, AND
 - b) A covenant is recorded that prohibits future such use of leachable metals on the *site* exposed to the weather (use the covenant in Reference Section 8-Q), AND
 - c) Less than 50% of the runoff draining to the proposed water quality facility is from any area of the *site* comprised of one or both of the following land uses:
 - Commercial land use with an expected ADT of 100 or more vehicles per 1,000 square feet of gross building area.
 - Commercial land use involved with vehicle repair, maintenance, or sales.
5. The **Basic WQ menu** may be used for treatment of any runoff from **target PGPS** that is treated separately from the runoff from **target PGIS**.
 6. The facility requirement as applied to **target PGPS** may be waived altogether for an **agricultural project** if there is a **farm management plan** for agricultural uses per KCC 21A.24 and KCC 16.82, or for other land uses if city review staff approves a **landscape management plan (LMP)** that controls solids, pesticides, fertilizers, and other erodible or leachable materials leaving the *site*.
 7. The facility requirement as applied to **replaced PGIS** may be waived if the City has adopted a plan and implementation schedule for fulfilling this requirement using **regional facilities**.

Note: If a lake management plan has been prepared and adopted by Kent, additional treatment and/or other water quality measures may be required as specified in the plan and pursuant to Special Requirement #1, Section 1.3.1.

1.2.8.2 WATER QUALITY IMPLEMENTATION REQUIREMENTS

Water quality facilities shall be designed and implemented in accordance with the following requirements, allowances, and flexible compliance provisions:

A. Methods of Analysis and Design

Water quality treatment facilities shall be analyzed and designed as detailed in Chapter 6.

B. Siting of Treatment Facilities

Required water quality facilities shall be located so as to treat the runoff from all target surfaces, except as allowed below under "Treatment Trades" and "Untreated Discharges."

Any other onsite or offsite runoff draining to a proposed treatment water quality facility must be treated whether it is from a **target pollution-generating surface** or not and regardless of whether the runoff has already been treated by another facility. The facility must be sized for all flows/volumes entering the facility. This is because treatment effectiveness is determined in part by the total volume of runoff entering the facility.

C. Treatment of Pervious Surfaces

Pollution-generating pervious surfaces subject to Core Requirement #8 need only be treated using the Basic WQ menu. It is also possible for the facility requirement to be waived if there is a good faith agreement with city review staff to approve a landscape management plan that controls solids, pesticides, and fertilizers leaving the site.

D. Treatment Trades

The runoff from **target pollution-generating surfaces** may be released untreated if an existing non-targeted pollution-generating surface of equivalent size and pollutant characteristics lying within the

same watershed or stream reach tributary area is treated on the project site. Such substitution is subject to all of the following restrictions:

1. The existing non-targeted pollution-generating surface is not currently being treated by any phase of the proposed project, is not subject to NPDES or other permit requirements, and is not under a compliance order or other regulatory action,
2. The existing non-targeted pollution-generating surface that is treated for purposes of the treatment trade must be documented and tracked by city review staff. Documentation should clarify that future redevelopment of the existing non-targeted, treated area used for the treatment trade will incur additional water quality treatment requirements if the redevelopment exceeds Core Requirement 8 thresholds. Any additional water quality treatment triggered by redevelopment of the non-targeted, treated area must be achieved by implementing an additional treatment trade.
3. The proposal is reviewed and approved by city review staff.

E. Untreated Discharges

If *site* topographic constraints are such that runoff from a **target pollution-generating surface** must be pumped to be treated by the required water quality facility, then city review staff may allow the area's runoff to be released untreated, provided that all of the following conditions are met:

1. Treatment of the constrained area by filter strip, biofiltration, or a linear sand filter is not feasible, and a **treatment trade** as described above is not possible.
2. The untreated target surface is less than 5,000 square feet of *new plus replaced PGIS*.
3. Any **target PGPS** within the area to be released untreated shall be addressed with a *landscape management plan* (LMP), which must be submitted to and approved by city review staff. The LMP applies to the entire site and all drainage area tributary to the site within one or more contiguous parcels under the same ownership or documented legal control.

F. Use of Experimental Water Quality Facilities

Water quality facilities other than those identified in Chapter 6 are allowed on an experimental basis if it can be demonstrated they are likely to meet the pollutant removal goal for the applicable receiving water. Use of such facilities requires an experimental design adjustment to be approved by Kent according to Section 1.4, "Adjustment Process." Experimental and proprietary BMPs may be allowed to provide pretreatment for filter BMPs or as the second WQ facility in the Two-Facility Treatment Train option. Applications will be reviewed on a case-by-case basis. For an experimental or proprietary BMP to be approved, it must be approved for use through the Washington Department of Ecology's TAPE Program.

G. Owner Responsibility for Water Quality

Regardless of the means by which a property owner chooses to meet the water quality requirements of this manual—whether a water quality facility, a train of facilities, a treatment trade, or an experimental water quality facility—it is ultimately the responsibility of the property owner to ensure that runoff from their *site* does not create water quality problems or degrade downstream beneficial uses. It is also ultimately the responsibility of the property owner to ensure that the discharge from their property is not in violation of State and Federal laws.

1.2.9 CORE REQUIREMENT #9: FLOW CONTROL BMPS

All proposed projects, including redevelopment projects, must provide onsite flow control BMPs to mitigate the impacts of storm and surface water runoff generated by new impervious surface, new pervious surface, existing impervious surfaces, and replaced impervious surface targeted for mitigation as specified in the following sections. Flow control BMPs must be selected and applied according to the basic requirements, procedures, and provisions detailed in this section and the design specifications for each BMP in Appendix C, Section C.2.

Flow control BMPs are methods and designs for dispersing, infiltrating, or otherwise reducing or preventing development-related increases in runoff at or near the sources of those increases. Flow control BMPs include, but are not limited to, preservation and use of **native vegetated surfaces** to fully disperse runoff; use of other pervious surfaces to disperse runoff; roof downspout infiltration; permeable pavements; bioretention; limited infiltration systems; and reduction of development footprint.

Intent: To provide mitigation of hydrologic impacts that is not possible/practical to mitigate with a flow control facility. Such impacts include increases in runoff volumes and flashiness and decreases in groundwater recharge. Increased runoff volume and flashiness leads to higher and more variable stream velocities at low flows and more frequent water level fluctuations in streams and wetlands. This causes wash-out and stranding of aquatic species, algal scour and washout of organic matter, loss of vegetation diversity and habitat quality, and disruption of cues for spawning, egg hatching, and migration. Decreased groundwater recharge reduces water supply for human use and summer base flows in streams, which is critical to water temperature, salmonid use of smaller streams, and the habitat quality of mainstream side channels and wetlands used for spawning, rearing, and flood refuge. Flow control BMPs seek to reduce runoff volumes and flashiness and increase groundwater recharge by reducing imperviousness and making use of the pervious portions of **development sites** to maximize infiltration and retention of stormwater onsite. Thus, the goal is to apply flow control BMPs to **new** impervious surfaces, new pervious surfaces, **replaced impervious surfaces**, and existing impervious surfaces added since January 8, 2001 (*effective date of the ESA 4(d) Rule for Puget Sound Chinook salmon*) to the maximum extent feasible without causing flooding or erosion impacts.

□ EXEMPTION FROM CORE REQUIREMENT #9

There is a single exemption from the flow control BMP provisions of Core Requirement #9:

1. Basic Exemption

A proposed project is exempt if it meets the following criteria:

- a) Less than 2,000 square feet of **new** plus **replaced impervious surface** will be created, AND
- b) Less than 7,000 square feet of land disturbing activity will occur.

1.2.9.1 FLOW CONTROL BMP REQUIREMENTS OVERVIEW

Projects that are subject to Core Requirement #9 must apply flow control BMPs to either supplement the flow mitigation provided by required flow control facilities or provide flow mitigation where flow control facilities are not required. All such flow control BMPs are detailed in Appendix C of this manual. Flow control BMPs must be implemented per the requirements and approach detailed in Sections 1.2.9.2 and

1.2.9.3 below for individual lots and subdivisions or road improvement projects, respectively. As described within Sections 1.2.9.2 and 1.2.9.3, there are two methods of satisfying the FCBMP requirement: (1) application of BMPs to the maximum extent feasible using lists specific to the project location, size, and impervious coverage; or (2) using a continuous runoff model to

demonstrate compliance with the Low Impact Development (LID) Performance Standard, described below.

Target surfaces

Target surfaces for application of Core Requirement #9 (FCBMPs) include new impervious surfaces, new pervious surfaces, replaced impervious surfaces, and any existing impervious surfaces added on or after January 8, 2001 (the effective date of the Endangered Species Act “take prohibition” issued by the federal government to protect Puget Sound Chinook salmon) not already mitigated with an approved FCBMP or flow control facility.

Projects that trigger Core Requirement #9 by disturbing 7,000 square feet or more of land, but where new plus replaced impervious is less than 2,000 square feet, may consider basic dispersion as an equal choice for treating the target impervious surfaces alongside full infiltration, limited infiltration, bioretention, and permeable pavement FCBMPs. These projects are not required to meet the minimum BMP implementation requirements described in “Small Lot BMP Requirements” and “Large Lot BMP Requirements,” (Requirement #5 on both lists), and are not required to comply with Core Requirement #6. Any impervious surface served by an infiltration facility designed in accordance with the flow control facility requirement (Section 1.2.3.1), the facility implementation requirements (Section 1.2.3.2), and the design criteria for infiltration facilities (Section 5.2) is exempt from the flow control BMPs requirement.

Any impervious or pervious surface served by the farmland dispersion BMP detailed in Appendix C, Section C.2.5, is exempt from the flow control BMPs requirement. Note that new pervious areas that are farmland dispersed are still required to comply with KCC 16.82.100 (F) and (G) as required to protect the soil moisture holding capacity.

Projects or threshold discharge areas of projects qualifying as exempt from the flow control facility requirement using the Direct Discharge Exemption in accordance with Section 1.2.3.1 do not have to achieve the Low Impact Development (LID) performance standard (described below), nor consider bioretention, permeable pavement, and full dispersion. However, the soil moisture holding capacity of **new pervious surfaces** on those projects (or portions of projects) must be protected in accordance with Kent Grading Standards and (G). Kent City Code Chapter 15.07. Full infiltration as detailed in Appendix C, Section C.2.2, Basic Dispersion per Appendix C, Section C.2.4, and perforated pipe connection as detailed in Appendix C, Section C.2.11 must be implemented for roofs, if feasible; and Basic Dispersion per Appendix C, Section C.2.4 must be implemented for other impervious surfaces, if feasible.

A. Low Impact Development Performance Standard

The LID Performance Standard is defined as follows:

*For the target surfaces subject to Core Requirement #9, Stormwater discharges shall match developed discharge durations to pre-developed durations for the range of pre-developed discharge rates from 8% of the 2-year peak flow to 50% of the 2-year peak flow. Assume **historic site conditions** as the predeveloped condition.*

Projects that are either required or opt to demonstrate compliance with the LID Performance Standard using a continuous runoff model must protect the soil moisture capacity of new pervious in accordance with Kent Grading Standards and Kent City Code Chapter 15.07.

Projects that are required or opt to model compliance with the LID Performance Standard are still subject to meeting applicable area specific flow control requirements as determined in Core Requirement #3 (Section 1.2.3).

Note that when demonstrating compliance with the LID Performance Standard, flow control BMPs are modeled explicitly, utilizing design infiltration rates as determined and selected per Section 5.2.1. However, when modeling flow control facility sizing, water quality facility sizing, and the

peak flow exceptions from the area-specific flow control facility requirement in Sections 1.2.3.1.A, B, and C, these BMPs are not modeled explicitly, but may use modeling credits as allowed and subject to the limitations described in Section 1.2.9.4 and Table 1.2.9.A. FCBMPs used to demonstrate compliance with the LID Performance Standard must meet the implementation requirements described in Section 1.2.9.4.

B. Implementation

Three kinds of implementation for the FCBMP requirement are described in this section as follows:

1. For **non-subdivision projects making improvements on an individual site/lot**, implementation of this requirement shall be in accordance with the "Individual Lot BMP Requirements" in Section 1.2.9.2, which specify the selection of BMPs and the extent of their application on the site/lot. This required implementation of flow control BMPs must occur as part of the proposed project and provisions must be made for their future maintenance as specified in Section 1.2.9.2. As allowed in Sections 1.2.3 and 1.2.8, credits for the application of flow control BMPs per Table 1.2.9.A may be used to reduce the size of a required flow control facility, reduce the size of a water quality facility, qualify for a flow control facility exception or bypass of target surfaces, or reduce the target surfaces subject to flow control or water quality facility requirements.
2. **For subdivision projects**, implementation of flow control BMPs for associated plat infrastructure improvements (e.g., roads, sidewalks) shall be done per Section 1.2.9.4 and must occur concurrently and as part of the proposed project, while BMPs associated with the individual lot improvements may be delayed until construction on the lots. As allowed in Sections 1.2.3 and 1.2.8, credits for the application of flow control BMPs per Table 1.2.9.A may be used to reduce the size of a required flow control facility, reduce the size of a water quality facility, qualify for a flow control facility exception or bypass of target surfaces, or reduce the target surfaces subject to flow control or water quality facility requirements. To use these credits, flow control BMPs must be implemented as part of the proposed project and provisions must be made for their future maintenance as specified in Section 1.2.9.4. For subdivision projects proposing to take credit for future implementation of BMPs on individual lots, provisions must be made to assure their implementation as specified in Section 1.2.9.4.
3. **For road improvement projects**, implementation of flow control BMPs must occur as part of the proposed project. As allowed in Sections 1.2.3 and 1.2.8, credits for the application of flow control BMPs per Table 1.2.9.A may be used to reduce the size of a required flow control facility, reduce the size of a water quality facility, qualify for a flow control facility exception or bypass of target surfaces, or reduce the target surfaces subject to flow control or water quality facility requirements. To use these credits, flow control BMPs must be implemented as part of the proposed project and provisions must be made for their future maintenance as specified in Section 1.2.9.4.

The information presented in this section is organized as follows:

- Section 1.2.9.2, "Individual Lot BMP Requirements"
 - “Small Lot BMP Requirements,” Section 1.2.9.2.1
 - “Large Lot BMP Requirements,” Section 1.2.9.2.2
 - “Implementation Requirements for Individual Lot BMPs,” Section 1.2.9.2.4
- Section 1.2.9.3, "Subdivision and Road Improvement Projects BMP Requirements"
 - “Small Subdivision and Urban Subdivision Projects BMP Requirements,” Section 1.2.9.3.1
 - “Small Road Improvement and Urban Road Improvement Projects BMP Requirements,”

Section 1.2.9.3.2

- Section 1.2.9.4, “Requirements for Use of BMP Credits”
 - “Use of Credits by Subdivision Projects,” Section 1.2.9.4.1
 - “Use of Credits by Projects within Rights-of-Way,” Section 1.2.9

1.2.9.2 INDIVIDUAL LOT BMP REQUIREMENTS

For projects on individual *sites/lots*, flow control BMPs must be selected and applied according to the individual lot BMP requirements in this section. For purposes of applying flow control BMPs to individual *sites/lots*, two categories of requirements have been established based on the size of *site/lot* subject to improvements by the project and the extent of impervious surface coverage resulting from the project on the *site/lot*. These categories of requirements are as follows:

- Small Lot BMP Requirements (for *sites/lots* <22,000 square feet)
- Large Lot BMP Requirements (for *sites/lots* ≥22,000 square feet)

Flow control BMPs must be applied in the order of preference and to the extent specified for the category of individual lot requirements applicable to the proposed project as described in the following subsections. *Note: for lots created by a previous subdivision, some or all of these requirements may have been addressed by flow control BMPs installed on the lots or within common areas, tracts, or road right-of-way. In some cases, the type of BMPs required for a subdivision lot have already been established by a recorded covenant on the lot. See Section 1.2.9.4 for more information on pre-installed or pre-determined BMPs in subdivision.*

1.2.9.2.1 SMALL LOT BMP REQUIREMENTS

IF the proposed project is on a *site/lot smaller than 22,000 square feet*, THEN flow control BMPs must be applied as specified in the requirements below OR the project must demonstrate compliance with the LID Performance Standard (described in Section 1.2.9.1.B, p. 1-62) using an approved continuous runoff model. Projects on small lots are typically single family residential improvements (e.g., homes, outbuildings, etc.) but could be a small commercial development.

1. The feasibility and applicability of full dispersion as detailed in Appendix C, Section C.2.1 must be evaluated for all target impervious surfaces. If feasible and applicable, **full dispersion** must be implemented as part of the proposed project. Typically, small lot full dispersion will be applicable only in subdivisions where enough forest was preserved by tract, easement, or covenant to meet the minimum requirements for full dispersion in Appendix C, Section C.2.1.1.
2. Where full dispersion of target impervious roof areas is not feasible or applicable, or will cause flooding or erosion impacts, the feasibility and applicability of full infiltration as detailed in Appendix C, Section C.2.2 must be evaluated (*note, this will require a soils report for the site/lot*). If feasible and applicable, **full infiltration of roof runoff** must be implemented as part of the proposed project.
3. All target impervious surfaces not mitigated by Requirements 1 and 2 above, must be mitigated to the maximum extent feasible using one or more BMPs from the following list. Use of a given BMP is subject to evaluation of its feasibility and applicability as detailed in Appendix C. Feasible BMPs are required to be implemented. The BMPs listed below may be located anywhere on the *site/lot* subject to the limitations and design specifications for each BMP. These BMPs must be implemented as part of the proposed project.

- **Full Infiltration** per Appendix C, Section C.2.2, or per Section 5.2, whichever is applicable
 - **Limited Infiltration** per Appendix C, Section C.2.3
 - **Bioretention** per Appendix C, Section C.2.6, sized as follows:
 - o Rainfall region SeaTac 1.0 and less: In till soils, provide bioretention volume based on 0.6 inches of equivalent storage depth; in outwash soils provide bioretention volume based on 0.1 inches of equivalent storage depth,
 - o Rainfall regions greater than SeaTac 1.0: In till soils, provide bioretention volume based on 0.8 inches of equivalent storage depth; in outwash soils, provide bioretention volume based on 0.4 inches of equivalent storage depth,
 - **Permeable Pavement** per Appendix C, Section C.2.7
4. All target impervious surfaces not mitigated by Requirements 1, 2 and 3 above, must be mitigated to the maximum extent feasible using the Basic Dispersion BMP described below. Use of Basic Dispersion is subject to evaluation of its feasibility and applicability as detailed in Appendix C. Feasible BMPs are required to be implemented. Basic Dispersion BMPs may be located anywhere on the *site/lot* subject to the limitations and design specifications cited in Appendix C. The BMP must be implemented as part of the proposed project.
- **Basic Dispersion** per Appendix C, Section C.2.4
5. BMPs must be implemented, at minimum, for an impervious area equal to at least 10% of the *site/lot* for *site/lot sizes up to 11,000 square feet* and at least 20% of the *site/lot* for *site/lot sizes between 11,000 and 22,000 square feet*. OR one or more BMPs from the following list are required to be implemented to achieve compliance. These BMPs must be implemented as part of the proposed project.
- **Reduced Impervious Surface Credit** per Appendix C, Section C.2.9
 - **Native Growth Retention Credit** per Appendix C, Section C.2.10
6. The soil moisture holding capacity of **new pervious surfaces** must be protected in accordance with Kent Grading Standards and Kent City Code Chapter 15.07. Kent Grading Standards require that the duff layer or native topsoil be retained to the maximum extent practicable. KCC 15.07 requires soil amendment to mitigate for lost moisture holding capacity where compaction or removal of some or all of the duff layer or underlying topsoil has occurred. The specifications for compost for soil amendment can be found in Reference 11-C.
7. Any proposed connection of roof downspouts to the *local drainage system* must be via a **perforated pipe connection** as detailed in Appendix C, Section C.2.11.

1.2.9.2.2 LARGE LOT BMP REQUIREMENTS

IF the proposed project is on a *site/lot* that is **22,000 square feet or larger**, THEN flow control BMPs must be applied as specified in the requirements below OR the project must demonstrate compliance with the LID Performance Standard (described in Section 1.2.9.1.B, p. 1- 62) using an approved continuous runoff model.

1. The feasibility and applicability of **full dispersion** as detailed in Appendix C, Section C.2.1 must be evaluated for all **target impervious surfaces**. If feasible and applicable for any such surface, then full dispersion must be applied to that surface and implemented as part of the proposed project. Typically, full dispersion will be applicable only on the largest *sites/lots* where there may be enough forest area available within a **threshold discharge area** to meet the 15% ratio of **fully dispersed** impervious area to **native vegetated surface**.

2. Where full dispersion of target impervious roof areas is not feasible or applicable, or will cause flooding or erosion impacts, the feasibility and applicability of **full infiltration of roof runoff** must be evaluated in accordance with Appendix C, Section C.2.2, or Section 5.2, whichever is applicable based on the type of project.²⁷ If feasible and applicable, full infiltration of roof runoff must be implemented as part of the proposed project.
3. All target impervious surfaces not mitigated by Requirements 1 and 2 above, must be mitigated to the maximum extent feasible using one or more BMPs from the following list. Use of a given BMP is subject to evaluation of its feasibility and applicability as detailed in Appendix C. Feasible BMPs are required to be implemented. The BMPs listed below may be located anywhere on the site/lot subject to the limitations and design specifications for each BMP. These BMPs must be implemented as part of the proposed project.
 - Full Infiltration** per Section C.2.2, or per Section 5.2, whichever is applicable
 - Limited Infiltration** per Appendix C, Section C.2.3
 - Bioretention** per Appendix C, Section C.2.6, sized as follows:
 - o Rainfall region SeaTac 1.0 and less: In till soils, provide bioretention volume based on 0.6 inches of equivalent storage depth; in outwash soils provide bioretention volume based on 0.1 inches of equivalent storage depth
 - o Rainfall regions greater than SeaTac 1.0: In till soils, provide bioretention volume based on 0.8 inches of equivalent storage depth; in outwash soils, provide bioretention volume based on 0.4 inches of equivalent storage depth,
 - Permeable Pavement** per Appendix C, Section C.2.7
4. All target impervious surfaces not mitigated by Requirements 1,2 and 3 above, must be mitigated to the maximum extent feasible using the Basic Dispersion BMP described below. Use of Basic Dispersion is subject to evaluation of its feasibility and applicability as detailed in Appendix C. Feasible BMPs are required to be implemented. Basic Dispersion BMPs may be located anywhere on the *site/lot* subject the limitations and design specifications cited in Appendix C. The BMP must be implemented as part of the proposed project.
 - Basic Dispersion** per Appendix C, Section C.2.4
5. BMPs must be implemented, at minimum, for impervious area amounts defined as follows. For projects that will result in an impervious surface coverage on the buildable portion of the site/lot of less than 45%, flow control BMPs must be applied to 50% of target impervious surfaces. For projects that will result in an impervious surface coverage 45-65% on the buildable portion of the site/lot, flow control BMPs must be applied to 50% of target impervious surfaces reduced by 1.5% for each 1% of impervious surface coverage above 45% (e.g. impervious coverage of 55% results in a requirement of FCBMPs applied to 35% of target impervious surfaces). For projects that will result in an impervious surface coverage greater than 65% on the buildable portion of the site/lot,

²⁷ For projects subject to Simplified Drainage Review, and for any *single family residential project* subject to Full Drainage Review, the design requirements and specifications in Appendix C, Section C.2.2 may be used for evaluation and design of full infiltration on individual lots. For all other projects, full infiltration must be evaluated and designed in accordance with the infiltration facility standards in Section 5.2.

flow control BMPs must be applied to 20% of the target impervious surfaces or to an impervious area equal to at least 10% of the site/lot, whichever is less. The buildable portion of the site/lot is the total area of the site/lot minus any critical areas and minus 200 ft. buffer areas from a **steep slope hazard, landslide hazard area, or erosion hazard area**. If these minimum areas are not mitigated using feasible BMPs from Requirements 1, 2, 3, and 4 above, one or more BMPs from the following list are required to be implemented to achieve compliance. These BMPs must be implemented as part of the proposed project.

- Reduced Impervious Surface Credit** per Appendix C, Section C.2.9
 - Native Growth Retention Credit** per Appendix C, Section C.2.10
6. The soil moisture holding capacity of **new pervious surfaces** must be protected in accordance with Kent Grading Standards and Kent City Code Chapter 15.07. Kent Grading Standards require that the duff layer or native topsoil be retained to the maximum extent practicable. KCC 15.07 requires soil amendment to mitigate for lost moisture holding capacity where compaction or removal of some or all of the duff layer or underlying topsoil has occurred. The amendment must take place between May 1 and October 1. The specifications for compost for soil amendment can be found in Reference 11-C.
 7. Any proposed connection of roof downspouts to the drainage system must be via a **perforated pipe connection** as detailed in Appendix C, Section C.2.11.

1.2.9.2.3 IMPLEMENTATION REQUIREMENTS FOR INDIVIDUAL LOT BMPS

The flow control BMPs required in Sections 1.2.9.2 above must be implemented in accordance with the following requirements:

1. **Implementation Responsibility.** All flow control BMPs required for the *site/lot* must be implemented (installed) by the applicant as part of the proposed project unless they have already implemented as part of a subdivision project that created the lot per Section 1.2.9.4.
2. **Maintenance Responsibility.** Maintenance of all required flow control BMPs is the responsibility of the owner of the *site/lot* served by these BMPs. The responsibility for such maintenance must be clearly assigned to the current and future owners of the *site/lot* through a “declaration of stormwater facility maintenance covenant” as described in Requirement 3 below.
2. **Declaration of Stormwater Facility Maintenance Covenant.** To ensure future maintenance of flow control BMPs and allow for City inspection of BMPs, a declaration of stormwater facility maintenance covenant must be recorded for each *site/lot* that contains flow control BMPs. A draft of the proposed covenant must be reviewed and approved by city review staff prior to recording. All required covenants must be recorded prior to final construction approval for the proposed project. The stormwater facility maintenance covenant can be obtained on the COK website or from plan review staff., and is designed to achieve the following:
 - a) Provide **notice** to future owners of the presence of flow control BMPs on the lot and the responsibility of the owner to retain, uphold, and protect the flow control BMP devices,

features, pathways, limits, and restrictions.

- b) Include as an **exhibit**, a *recordable version*²⁸ of the following drainage plan information:
- The **flow control BMP site plan** showing all developed surfaces (impervious and pervious) and the location and dimensions of flow control BMP devices, features, flowpaths (if applicable), and limits of native growth retention areas (if applicable). This plan(s) must be to scale and include *site* topography in accordance with the specifications for such plans in Appendix C, Section C.4.2. Also indicate any areas where City access is excluded (see paragraph 3.d below). *Note: DPER may waive this element if, for example, the only flow control BMP proposed is a limit on impervious surface (reduced footprint).*
 - The **flow control BMP design and maintenance details** for each flow control BMP per Appendix C, Section C.4.3. This includes a diagram (if applicable) of each flow control BMP device or feature and written maintenance and operation instructions and restrictions for each device, feature, flowpath (if applicable), native growth retention area (if applicable) and impervious surface coverage (if applicable). See Reference M for prepared 8-1/2"x11" maintenance instruction sheets.
- Assure the exhibits are correctly cross-referenced in the declaration of covenant (the site plan is typically Exhibit A and the design/maintenance details are typically Exhibit B).
- c) Require that each flow control BMP be operated and **maintained at the owner's expense** in accordance with the above exhibit.
- d) Grant the City of Kent or its successor the **right to enter** the property at reasonable times for purposes of inspecting the flow control BMPs and to perform any corrective maintenance, repair, restoration, or mitigation work on the flow control BMPs that has not been performed by the property owner within a reasonable time set by the City of Kent, and to charge the property owner for the cost of any maintenance, repair, restoration, or mitigation work performed by the City of Kent.

The right to enter typically applies to the entire property, but occasionally exempts areas on the property agreed upon by the City to be excluded from access. Such areas are to be shown on the site plan described above.

- e) Prohibit any **modification or removal** of flow control BMPs without written approval from the City of Kent. In cases where the modification or removal is done under a City of Kent development permit, the approval must be obtained from city review staff and a covenant must be recorded to reflect the changes. In all other cases, the approval must be obtained from city review staff and a covenant must be recorded to reflect the changes. Approval will be granted only if equivalent protection in terms of hydrologic performance is provided by other means.

4. **Timing of Implementation.** All required flow control BMPs must be installed prior to final inspection approval of constructed improvements. For BMPs that rely on vegetation, the vegetation must be planted and starting to grow prior to final construction approval.

²⁸ Recordable version means one that meets Kent's "Standard Formatting Requirements for Recording Documents" pursuant to RCW 36.18.010 and 65.04.045, available online at http://your.kingcounty.gov/recelec/records/docs/formatting_requirements.pdf or from the King County Recorder's Office. These requirements include specifications for such things as page size (8-1/2" x 14" or smaller), font size (at least 8-point), and margin width (1" on all sides of every page if there is a standard cover sheet).

5. **Acceptance standards.** Flow control BMPs may be inspected during and/or following construction. Approval of the constructed BMPs will be based on verification that the materials and placement appear to meet the specifications and that the BMPs appear to function as designed. Onsite observations may be used to verify that materials are as specified and material receipts checked. Performance may be evaluated by a *site* visit while it is raining or by testing with a bucket of water or garden hose to check pavement permeability or proper connection to BMP devices/features, etc.
6. **Drainage concerns.** If city review staff determines that there is a potential for drainage impacts to a neighboring property, then additional measures may be required. Some flow control BMPs may not be appropriate in certain situations, and will not be allowed by city review staff where they may cause drainage problems.
7. **Geotechnical concerns.** A geotechnical engineer, engineering geologist, or city review staff contracted geologist must evaluate and approve flow control BMPs that are proposed: (A) on slopes steeper than 15%; (B) within a setback from the top of slope equal to the total vertical height of the slope area that is steeper than 15%; or (C) within 200 feet of a *steep slope hazard area, erosion hazard area, or landslide hazard area*. In addition, city review staff may require review by a geotechnical engineer or engineering geologist of any proposed BMP that infiltrates, disperses, or directs overflow adjacent to or towards a *steep slope hazard area, erosion hazard area, or landslide hazard area*. City review staff may also require some projects to route flows down or around such slopes using non-perforated pipes. Some flow control BMPs may not be appropriate for these locations, and will not be allowed by city review staff where flows may cause erosion problems.
8. **Sewage system concerns.** If city review staff determines that there is a potential conflict between onsite sewage systems and flow control BMPs, additional measures may be required. Some projects may need to route flows past onsite sewage systems using non-perforated pipes. Also, some flow control BMPs may not be appropriate for these *sites*, and will not be allowed where sewage systems may be impacted.

1.2.9.3 SUBDIVISION AND ROAD IMPROVEMENT PROJECTS BMP REQUIREMENTS

For subdivision and road improvement projects, flow control BMPs must be selected and applied according to the subdivision and road improvement projects BMP requirements in this section. For purposes of applying flow control BMPs to these projects, two categories of requirements have been established based on the size of *site/lot* subject to improvements and by the project. These categories of requirements are as follows:

- **Subdivision Projects BMP Requirements**
- **Road Improvement Projects BMP Requirements**

Flow control BMPs must be applied in the order of preference and to the extent specified for the category of requirements applicable to the proposed project as described in the following subsections.

1.2.9.3.1 SUBDIVISION PROJECTS BMP REQUIREMENTS

IF the proposed project is a **subdivision project**, THEN Flow control BMPs for plat infrastructure improvements (e.g., road and sidewalk etc.) of these projects shall meet the requirements described in Section 1.2.9.3.2 below for “Road Improvement Project BMP Requirements.” Implementation of flow control BMPs required for/on the individual lots of the subdivision may be deferred until a permit is obtained for construction on each lot and is therefore optional. However, if the applicant wishes to implement or make provision for implementation of BMPs for the lot improvements as part of the subdivision project for purposes of receiving BMP modeling credits, the individual lot BMP requirements

described in Section 1.2.9.2 and implementation requirements for subdivision projects described Section 1.2.9.4.1 must be met.

1.2.9.3.2 ROAD IMPROVEMENT PROJECTS BMP REQUIREMENTS

IF the proposed project is a **road improvement project**, THEN flow control BMPs must be applied as specified in the requirements below.

1. The feasibility and applicability of full dispersion as detailed in Appendix C, Section C.2.1 must be evaluated for all target impervious surfaces. If feasible and applicable, **full dispersion** must be implemented as part of the proposed project. Typically, small lot full dispersion will be applicable only in subdivisions where enough forest was preserved by tract, easement, or covenant to meet the minimum requirements for full dispersion in Appendix C, Section C.2.1.1.
2. All target impervious surfaces not mitigated by Requirement 1 above, must be mitigated to the maximum extent feasible using one or more BMPs from the following list. Use of a given BMP is subject to evaluation of its feasibility and applicability as detailed in Appendix C. Infeasible BMPs are not required to be implemented. The BMPs listed below may be located anywhere on the **site/lot** subject to the limitations and design specifications for each BMP. These BMPs must be implemented as part of the proposed project.
 - **Full Infiltration** per Section C.2.2, or per Section 5.2, whichever is applicable
 - **Limited Infiltration** per Appendix C, Section C.2.3
 - **Bioretention** per Appendix C, Section C.2.6, sized as follows:
 - o Rainfall region SeaTac 1.0 and less: In till soils, provide bioretention volume based on 0.6 inches of equivalent storage depth; in outwash soils provide bioretention volume based on 0.1 inches of equivalent storage depth,
 - o Rainfall regions greater than SeaTac 1.0: In till soils, provide bioretention volume based on 0.8 inches of equivalent storage depth; in outwash soils, provide bioretention volume based on 0.4 inches of equivalent storage depth,
 - **Permeable Pavement** per Appendix C, Section C.2.7
3. All target impervious surfaces not mitigated by Requirements 1 and 2 above, must be mitigated to the maximum extent feasible using the Basic Dispersion BMP described below. Use of Basic Dispersion is subject to evaluation of its feasibility and applicability as detailed in Appendix C. Infeasible BMPs are not required to be implemented. Basic Dispersion BMPs may be located anywhere on the **site/lot** subject to the limitations and design specifications cited in Appendix C. The BMPs must be implemented as part of the proposed project.
 - **Basic Dispersion** per Appendix C, Section C.2.4
4. The soil moisture holding capacity of **new pervious surfaces** must be protected in accordance with Kent Grading Standards and Kent City Code Chapter 15.07. Kent Grading Standards require that the duff layer or native topsoil be retained to the maximum extent practicable. KCC 15.07 requires soil amendment to mitigate for lost moisture holding capacity where compaction or removal of some or all of the duff layer or underlying topsoil has occurred. The amendment must take place between May 1 and October 1. The specifications for compost for soil amendment can be found in Reference 11-C.

1.2.9.4 REQUIREMENTS FOR USE OF BMP CREDITS

Projects that implement flow control BMPs, whether required or optional, may use the flow control

BMP credits described in this section subject to the implementation requirements in Section 1.2.9.2.4 (for Individual Lots), Section 1.2.9.4.1 below (for Subdivision Projects), and Section 1.2.9.4.2 below (for Right of Way Projects).

Two kinds of credits are available. First, any impervious surface served by a flow control BMP that meets the design specifications for that BMP in Appendix C may be modeled as indicated in Table 1.2.9.A (below). Such credits may be used in the following situations:

1. To compute post-development runoff time series when sizing required flow control facilities.
2. To compute post-development 100-year peak flows when assessing any of the peak flow exceptions from the area-specific flow control facility requirement in Sections 1.2.3.1.A, B, and C.
3. To compute post-development runoff time series when sizing required flow rate based water quality facilities (e.g., bioswales) and to re-characterize post developed land types when sizing volume based water quality facilities (e.g., wetponds, wetvaults).

Use of credits for water quality facility sizing as described above is limited to BMPs that are treating flows downstream from the BMP and tributary to a required water quality facility.

Second, any impervious or non-native pervious surface that is *fully dispersed* per the full dispersion criteria in Section 1.2.3.2.C is **not** considered a target surface of the area-specific flow control facility requirement (Section 1.2.3.1) or the area-specific water quality facility requirement (Section 1.2.8.1)

TABLE 1.2.9.A FLOW CONTROL BMP FACILITY SIZING CREDITS⁽¹⁾

Flow Control BMP Type	Facility Sizing Credit
Full dispersion	Model fully dispersed surface as forest ⁽²⁾
Full infiltration ⁽³⁾	Subtract impervious area that is fully infiltrated
Limited infiltration	Model tributary impervious surface as 90% impervious, 10% grass
Basic dispersion	Model dispersed impervious surface as 90% impervious, 10% grass
Farmland dispersion	Dispersed areas are considered non-targeted for flow control. Dispersed areas on sites with farm management plans are considered non-targeted for water quality treatment.
Bioretention	Model tributary impervious surface as 90% impervious, 10% grass
Permeable pavement (unlined with no underdrain)	Model permeable pavement area as 50% impervious, 50% grass
Grassed modular grid pavement	Model modular grid pavement as all grass
Rainwater harvesting	Credit only allowed via and as specified in an approved drainage adjustment that details conditions of use.
Restricted footprint	Model footprint as restricted
Wheel strip driveways	Model credited area as 50% impervious, 50% grass
Minimum disturbance foundation	Model foundation area as 50% impervious, 50% grass
Open grid decking over pervious area	Model deck area as 50% impervious, 50% grass
Native growth retention credit	Model mitigated impervious area as 50% impervious, 50% grass
Perforated pipe connection	None
Notes:	
<p>⁽¹⁾ These credits do not apply when determining eligibility for exemptions from Core Requirement #3, Core Requirement #8, or exceptions from the flow control or water quality facility requirements unless otherwise noted in the exemption or exception. Explicit modeling of BMP infiltration for facility sizing is not allowed. When applying modeling credits for flow control facility sizing, infiltrative BMPs tributary to the facility that are included in the modeling scenario (including the permeable pavement element with area reduced to 50% impervious area fraction, or other BMPs (e.g., bioretention, trenches, drywells) treating upstream runoff) must have the infiltration option <i>turned off</i> during the flow routing analysis for facility sizing to avoid double-counting the BMP infiltration benefit. Alternatively, the permeable pavement BMP with infiltration turned off may be represented by an impervious area land use element of equivalent area.</p> <p>⁽²⁾ Surface shall be modeled using the soil type found at that location on the site.</p> <p>⁽³⁾ For any project subject to Simplified Drainage Review, and for any single family residential project subject to Directed, Full or Large Project Drainage Review, the design requirements and specifications in Appendix C, Section C.2.2 may be used for design of full infiltration on individual lots. For all other projects, including any project where full infiltration is proposed to serve more than one lot, full infiltration must be designed in accordance with infiltration facility standards in Section 5.2.</p>	

1.2.9.4.1 USE OF CREDITS BY SUBDIVISION PROJECTS

If a proposed project is a *subdivision project*,²⁹ implementation of flow control BMPs for plat infrastructure improvements (e.g., road, sidewalk, or other non-lot improvements) is required concurrent with the subdivision improvements. Implementation of flow control BMPs on the individual lots of the subdivision may be deferred until a permit is obtained for construction on each lot and is therefore optional as part of the subdivision project.

In order to receive the modeling credits (noted above) for flow control BMPs required for plat infrastructure improvements (e.g., road, sidewalk, or other non-lot improvements), and/or for individual lot BMPs where the applicant elects to implement or make provision for implementation of individual lot BMPs as part of the subdivision project, the following requirements must be met depending on where the BMPs are located on the *site*.

A. Subdivision Implementation of BMPs within Road Right-of-Way

These are flow control BMPs installed within public or private road right-of-way as part of the construction of street and drainage improvements for the subdivision. To receive credit for these BMPs, the subdivision project must meet all of the following requirements:

1. The BMPs must serve impervious surface located only within the road right-of-way.
2. The BMPs must be shown on the **site improvement plans** submitted with the engineering plans for the proposed project as specified in Section 2.3.1.2.
3. If the road right-of-way will be maintained by the City of Kent, the BMPs must be approved by the City of Kent Department of Public Works Operations through a **road variance** prior to engineering plan approval.
4. If the road right-of-way will be privately maintained, provision must be made for future **maintenance** of the BMPs in accordance with Core Requirement #6, Section 1.2.6. As specified in Core Requirement #6, the City of Kent will assume maintenance of such BMPs in certain cases.
5. If the City of Kent will be assuming maintenance of the BMPs, the BMPs must comply with the drainage facility **financial guarantee and liability requirements** in Core Requirement #7, Section 1.2.7.

B. Subdivision Implementation of BMPs within Dedicated Tracts

These are flow control BMPs installed on or associated with the features (e.g., forest) of common area tracts dedicated by the subdivision. Such BMPs may serve future improvements on lots, common area improvements, or road right-of-way improvements. To receive credit for these BMPs, the subdivision project must meet all of the following requirements:

1. The BMPs must be shown on the **site improvement plans** submitted with the engineering plans for the proposed project as specified in Section 2.3.1.2.
2. Provision must be made for future **maintenance** of the BMPs in accordance with Core Requirement #6, Section 1.2.6. When maintenance by the City of Kent is specified by Core Requirement #6, the City of Kent will assume maintenance of BMP devices (e.g., dispersion

²⁹ For purposes of applying flow control BMPs, the term *subdivision* or *subdivision project* refers to any project that is a short plat, plat, or binding site plan.

trenches) that are within a tract dedicated to the City for drainage purposes. The City of Kent will not assume maintenance of BMP devices located in common areas dedicated for purposes other than just drainage (e.g., play areas, parks, etc.). Where the City of Kent maintenance is specified by Core 6, the City will assume maintenance for FCBMP vegetated flow paths that are within an easement that allows for inspection and maintenance by the City. The City of Kent maintenance of these vegetated flow paths will be limited to their FCBMP functionality. All other maintenance shall remain the responsibility of the owner(s).

3. BMPs to be maintained by the City of Kent in accordance with Core Requirement #6 must comply with the drainage facility **financial guarantee and liability requirements** in Core Requirement #7, Section 1.2.7.
4. If the BMPs installed within a dedicated tract satisfy some or all of the BMP requirements for individual lots per Section 1.2.9.2, then a **note** must be placed on the **recorded documents** for the subdivision indicating those lots for which BMPs have been provided.

C. Subdivision Implementation of BMPs on Individual Lots

These are flow control BMPs installed on a subdivision's proposed lots as part of the subdivision project. For example, the subdivision developer may elect to pre-install some or all of the flow control BMPs required by the individual lot BMP requirements in Section 1.2.9.2. To receive credits for these BMPs, the subdivision project must meet all of the following requirements:

1. The flow control BMPs must be installed and implemented in accordance with the individual lot BMP requirements in Section 1.2.9.2. This includes recording a **declaration of covenant and grant of easement** for each lot with BMPs as specified in Implementation Requirement 3 of Section 1.2.9.2.4. If not all of the required BMPs are installed on a lot as part of the subdivision project, language must be included in the covenant notifying the future lot owner of additional required BMPs.
2. BMPs to be installed on individual lots as part of the subdivision project must be shown on the **site improvement plans** submitted with the engineering plans for the proposed project as specified in Section 2.3.1.2.

D. Subdivision Future Implementation of BMPs on Individual Lots

These are flow control BMPs stipulated to be installed on some or all of a subdivision's proposed lots by a declaration of covenant recorded for each such lot. To receive credits for these BMPs, the subdivision project must meet all of the following requirements:

1. Demonstrate through a lot-specific assessment that the flow control BMPs stipulated for each lot are **feasible and applicable** according to the individual lot BMP requirements in Section 1.2.9.2 and the BMP design specifications in Appendix C. This lot-specific assessment must be included in the TIR submitted with engineering plans for the subdivision. The assessment shall include any soils reports, calculations, or other information necessary to select and properly apply BMPs.
2. Record a **declaration of covenant and grant of easement** for each lot stipulating the type or types of BMP being proposed for credit. This covenant must be as specified in Implementation Requirement 3 of Section 1.2.9.2.4, except as follows:
 - a) The **FCBMP site plan(s)** may be waived depending on the BMPs proposed or may be conceptual, showing only the information necessary to stipulate the type or types of BMP being proposed for credit. For example, if the BMP is full dispersion, the approximate location of future impervious surface and the limits of the "native vegetated flowpath segment" (see Appendix C, Section C.2.1) must be shown. If the BMP is full infiltration, the approximate location of future impervious surface, septic drain field (if applicable), and infiltration devices must be shown. For all other BMPs, the "design and maintenance

details" (see Item b below) for each proposed BMP per Appendix C may be sufficient as determined by city review staff.

- b) The **FCBMP design and maintenance details** must include the dimensions of all proposed devices, features, and flowpaths, expressed as unit amounts per square foot of impervious surface served or as a percentage of the lot size or impervious surface created.
 - c) The **notice** to future lot owners must indicate that they are responsible to install the flow control BMP or BMPs stipulated for the lot prior to final inspection approval of constructed lot improvements. Alternative BMPs that provide equivalent performance may be proposed at the time of permit application for proposed lot improvements. In any case, a revised covenant will need to be recorded to reflect the final approved BMPs and site improvement plan(s).
3. If **single family residential lots** are being created, a **note** must be placed on the **recorded documents** for the subdivision indicating the following:

"Single family residences and other improvements constructed on the lots created by this subdivision must implement the flow control best management practices (BMPs) stipulated in the drainage plan declaration of covenant and grant of easement recorded for each lot. Compliance with this stipulation must be addressed in the small project drainage plan submitted for drainage review when application is made for a single family residential building permit for the lot."

4. If **commercial lots** are being created, a **note** must be placed on the **recorded documents** for the subdivision indicating the following:

"Improvements constructed on the lots created by this subdivision must implement the flow control best management practices (BMPs) stipulated in the drainage plan declaration of covenant and grant of easement recorded for each lot. Compliance with this stipulation must be addressed in the engineering plans submitted for drainage review when application is made for a permit to make improvements to the lot."

5. If a **binding site plan** is being created, a **note** must be placed on the **recorded documents** for the subdivision indicating the following:

"Improvements constructed on the lots created by this binding site plan must implement the flow control best management practices (BMPs) stipulated in the drainage plan declaration of covenant and grant of easement recorded for each lot. Compliance with this stipulation must be addressed in the engineering plans submitted for drainage review when application is made for a permit to make improvements to the lot."

1.2.9.4.2 USE OF CREDITS BY PROJECTS WITHIN RIGHT-OF-WAY

If a proposed project is located primarily within an established public or private right-of-way, implementation of flow control BMPs is as required per Section 1.2.9.3. To receive credit for these BMPs, the project must meet all of the following requirements:

- 1. The BMPs must serve **impervious surface** located only within the right-of-way.
- 2. If the right-of-way is **road right-of-way** that will be maintained by the City of Kent, the BMPs must be approved by the City of Kent Department of Public Works Operations through a **road variance** prior to engineering plan approval.
- 3. If the right-of-way will be privately maintained, provision must be made for future **maintenance** of the BMPs in accordance with Core Requirement #6, Section 1.2.6. As specified in Core Requirement #6, the City of Kent will assume maintenance of such BMPs in certain cases.
- 4. If the City of Kent will be assuming maintenance of the BMPs, the BMPs must comply with the

drainage facility **financial guarantee and liability requirements** in Core Requirement #7, Section 1.2.

1.3 SPECIAL REQUIREMENTS

This section details the following five special drainage requirements which may apply to the proposed project depending on its location or *site*-specific characteristics:

- Special Requirement #1: Other Adopted Area-Specific Requirements, Section 1.3.1
- Special Requirement #2: Flood Hazard Area Delineation, Section 1.3.2
- Special Requirement #3: Flood Protection Facilities, Section 1.3.3
- Special Requirement #4: Source Control, Section 1.3.4
- Special Requirement #5: Oil Control, Section 1.3.5

1.3.1 SPECIAL REQUIREMENT #1: OTHER ADOPTED AREA-SPECIFIC REQUIREMENTS

Other adopted area-specific regulations may be adopted and include additional requirements that have a more direct bearing on the drainage design of a proposed project. An example is a basin plan or lake management plan that is adopted by the City.

- **Basin Plans (BPs):** The City may adopt basin plans to provide for the comprehensive assessment of resources and to accommodate growth while controlling adverse impacts to the environment. A basin plan may recommend specific land uses, regional capital projects, and special drainage requirements for future development within the basin area it covers.
- **Master Drainage Plans (MDPs):** MDPs are comprehensive drainage plans prepared for urban planned developments (UPDs) or other large, complex projects (described in Section 1.1.2.5). Projects covered by a MDP must meet any adopted requirements specific to that plan.
- **Salmon Conservation Plans (SCPs):** Salmon conservation plans are comprehensive, ecosystem based plans intended to identify and assess the means to protect and restore salmon habitat through mechanisms such as habitat improvements, regulations, incentives, BMPs, land acquisition, and public education activities. These plans are developed in collaboration with other jurisdictions within a water resource inventory area (WRIA) designated by the state under WAC 173-500-040 and spanning several basins or subbasins.
- **Flood Hazard Management Plan (FHMPs):** The King County Flood Hazard Management Plan and related updates is a regional plan prepared in accordance with RCW 86.12.200 and is a functional element of the King County Comprehensive Plan for the purpose of reducing flood risks. It includes (1) policies to guide floodplain land use and flood risk reduction activities; (2) geographically based descriptions of hazards and associated strategic vision; (3) program and project recommendations, including capital improvement projects, maintenance, relocation and elevation of homes, flood warning improvements, and river planning activities; and (4) implementation priorities for program and project recommendations. The FHMP is updated every 5 years.
- **Lake Management Plans (LMPs):** The City may adopt lake management plans to provide for comprehensive assessment of resources and to accommodate growth while controlling adverse impacts from nutrient loading to selected lakes. A lake management plan may recommend nutrient control through special drainage and source control requirements for proposed projects within the area it covers.

Threshold	Requirement
IF a proposed project is in a basin plan or lake management plan...	THEN the proposed project shall comply with the drainage requirements of the basin plan or management plan, respectively.

Application of this Requirement

The drainage requirements of adopted area-specific regulations such as basin plans shall be applied in addition to the drainage requirements of this manual unless otherwise specified in the adopted regulation. Where conflicts occur between the two, the drainage requirements of the adopted area-specific regulation shall supersede those in this manual.

Examples of drainage requirements found in other adopted area-specific regulations include the following:

- * More or less stringent flow control
- * More extensive water quality controls
- * Forest retention requirements
- * Infiltration restrictions
- * Groundwater recharge provisions
- * Discharge to a constructed regional flow control or conveyance facility.

1.3.2 SPECIAL REQUIREMENT #2: FLOOD HAZARD AREA DELINEATION

Flood hazard areas are composed of the 100-year floodplain, zero-rise flood fringe, zero-rise floodway, FEMA floodway, and channel migration zones as described in KCC 21A.24. If a proposed project contains or is adjacent to a *flood hazard area* as determined by Economic and Community Development, this special requirement requires the project to determine those components that are applicable and delineate them on the project's site improvement plans and recorded maps.

Floodplains and floodways are subject to inundation during extreme events. The 100-year floodplains are delineated to minimize flooding impacts to new development and to prevent aggravation of existing flooding problems by new development. Regulations and restrictions concerning development within a 100-year floodplain are found in Chapter 14.09 of the Kent City Code.

The following requirements relate to mapping of the floodplain/floodway and compensatory storage requirements.

Threshold	Requirement
IF a proposed project contains or is adjacent to a stream, lake, wetland, or closed depression, or if other Kent regulations require study of flood hazards . . .	THEN the 100-year floodplain boundaries (and floodway, if available or if improvements are proposed within the 100-year floodplain) based on an approved flood hazard study (described below) shall be delineated on the site improvement plans and profiles, and on any final subdivision maps prepared for the proposed project.

IF a proposed project proposes to fill within a FEMA designated floodplain that is outside of the floodway (also known as the floodway fringe)	THEN the development must provide offsetting storage for 100% of the pre-development floodway fringe storage capacity that was provided on the property that is to be filled.
--	---

Application of this Requirement

If an approved flood hazard study exists, then it may be used as the basis for delineating the floodplain and floodway boundaries provided the study was prepared in a manner consistent with this manual and other Kent flood hazard regulations. If an approved flood hazard study does not exist, then one shall be prepared based on the requirements described in Section 4.4.2, "Floodplain/Floodway Analysis."

Projects proposing to fill or alter the floodplain and/or floodway must prepare a flood hazard study that analyzes and documents the effect of the proposed development and mitigating measures.

1.3.3 SPECIAL REQUIREMENT #3: FLOOD PROTECTION FACILITIES

Developing sites protected by levees, revetments, or berms requires a high level of confidence in their structural integrity and performance. Proper analysis, design, and construction is necessary to protect against the potentially catastrophic consequences if such facilities should fail.

<i>Threshold</i>	<i>Requirement</i>
<p>IF a proposed project either:</p> <ul style="list-style-type: none"> • contains or is adjacent to a stream that has an existing flood protection facility (such as a levee, revetment, or berm), OR • proposes to construct a new or to modify an existing flood protection facility . . . 	<p>THEN the applicant shall demonstrate that the flood protection facility, as determined by a licensed professional engineer, conforms with siting, structural stability, environmental, and all other relevant standards cited in the following regulations and documents:</p> <ul style="list-style-type: none"> • Washington State <i>Integrated Streambank Protection Guidelines</i>, • Corps of Engineers <i>Manual for Design and Construction of Levees</i> (EM 1110-2-1913), • KCC 14.09 and • Special Requirement #1 (specifically the King County Flood Hazard Management Plan) <p>AND, flood containment levees shall meet or exceed the professional engineering standards summarized in FEMA National Flood Insurance mapping regulations (44 CFR, subsection 65.10) or FEMA's Analysis and Mapping Procedures for non-Accredited Levee Systems.</p>

Application of this Requirement

Conformance with the requirements listed above shall be addressed in the Technical Information Report submitted with the project's engineering plans (see Section 2.3.1.1).

Conformance also requires that certain **easement requirements** (outlined in Section 4.1) be met in order to allow City access to the facility. If the proposed project contains an existing City of Kent flood protection facility or proposes to rely on a City of Kent flood protection facility, the applicant shall provide an easement to the City of Kent consistent with the river protection easement requirements outlined in Section 4.1.

1.3.4 SPECIAL REQUIREMENT #4: SOURCE CONTROLS

Water quality source controls prevent rainfall and runoff water from coming into contact with pollutants, thereby reducing the likelihood that pollutants will enter public waterways and violate water quality standards. King County prepared a *Stormwater Pollution Control Manual* for citizens, businesses, and industries to identify and implement source controls for activities that often pollute water bodies. Kent provides advice on source control implementation upon request. The City may, however, require mandatory source controls at any time through formal code enforcement if complaints or studies reveal water quality violations or problems.

Threshold	Requirement
<p>IF a proposed project is either:</p> <ul style="list-style-type: none"> • a commercial, industrial, or multifamily site development, OR • a redevelopment project proposing improvements to an existing commercial, industrial, multifamily site . . . 	<p>THEN the project must provide water quality source controls applicable to the proposed project in accordance with the <i>King County Stormwater Pollution Control Manual</i>.</p>

Application of this Requirement

When applicable per the *Stormwater Pollution Prevention Manual*, structural source control measures, such as car wash pads or dumpster area roofing, shall be applied to the entire *site* containing the proposed project, not just the *project site*. If the applicant is a tenant or lessee for only a portion of the *site*, city review staff may limit the entire *site* application of structural source controls to only that portion of the *site* occupied or leased by the applicant. All applicable structural source control measures, such as covering storage piles with plastic or isolating areas where pollutants are used or stored, are to be implemented after occupancy and need not be addressed during the plan review process. All commercial and industrial projects (irrespective of size) undergoing drainage review are required to implement applicable source controls.

Activities That May Result In Structural Improvements

There are a number of activities that may require structures and/or specific drainage configurations in order to protect stormwater and maintain compliance with city code. Roof structures, wheel washes, cement pads, shutoff valves, containment berms and indoor mop sinks are all examples of things that need to be in place prior to commencing the activity. These may require building permits and other approvals prior to construction.

Below are some highlighted activities and the numbered BMP activity sheets in the *Stormwater Pollution Prevention Manual* that provide more detail:

Commercial Composting

Structural improvements: paved composting and storage pads, leachate collection system, lined collection ponds, wheel wash system

- A-24 Commercial Composting

Fueling of equipment and vehicles

Structural improvements: Portland cement pads, roofs, spill control devices, trench drains, oil/water separators

- A-17 Fueling Operations
- A-48 Older Fueling Operations

Horse stables

Structural improvements: Wash racks connected to sanitary sewer or separate infiltration area, manure containment areas

- A-35 Livestock

Processing and Stockpiling of sand or gravel

Structural improvements: Wheel wash system and track-out control, catch basin inserts

- A-41 Wheel Wash System

Painting, Finishing, & Coating of Vehicles & Equipment

Structural improvements: Permitted, enclosed paint booths

- A-22 Painting, Finishing, & Coating of Vehicles, Products, & Equipment

Restaurants and food trucks

Structural improvements: Indoor sinks for mat and rack washing and mop and wastewater disposal.

- A-8 Storage of Solid and Food Wastes
- A-12 Cleaning of Cooking Equipment
- A-39 Roof Vents and Fugitive Emissions

Outdoor storage of erodible materials, e.g. compost, bark, sand, etc.

Structural improvements: Wheel wash system and track-out control, berms, containment areas, covering, catch basin inserts

- A-41 Wheel Wash and Tire Bath Track-Out Control

Outdoor storage or processing of galvanized materials

Structural improvements: Roofs or other covering, stormwater collection and treatment system

- A-21 Manufacturing and Post-Processing of Metal Products

Storage of liquid materials

Structural improvements: Secondary containment, roofed structures, spill control devices

- A-2 Storage of Liquid Materials in Stationary Tanks
- A-3 Storage of Any Liquid Materials in Portable Containers

Utility Corridor Maintenance

Structural improvements: Road stabilization

- A-45 Maintenance of Public & Private Utility Corridors & Facilities

Washing of cars, trucks and equipment (not just commercial car washes)

Structural improvements: Dedicated wash pads, sewer connection, holding tanks, catch basin inserts

- A-13 Vehicle washing

Wood Treatment & Preserving

Structural improvements: Paved, contained and covered storage and processing areas

- A-23 Wood Treatment & Preserving

1.3.5 SPECIAL REQUIREMENT #5: OIL CONTROL

Projects proposing to develop or redevelop a **high-use site** must provide oil controls in addition to any other water quality controls required by this manual. Such **sites** typically generate high concentrations of oil due to high traffic turnover, on-site vehicle or heavy or stationary equipment use, some business operations, e.g., automotive recycling, or the frequent transfer of liquid petroleum or coal derivative products..

A high-use site is any one of the following:

- * A commercial or industrial site subject to an expected average daily traffic (ADT) count equal to or greater than 100 vehicles per 1,000 square feet of gross building area, OR
- * A commercial or industrial site subject to petroleum storage and transfer in excess of 1,500 gallons per year, not including routinely delivered heating oil, OR
- * A commercial or industrial site subject to use, storage, or maintenance of a fleet of 25 or more diesel vehicles that are over 10 tons gross weight (trucks, buses, trains, heavy equipment, etc.), OR
- * A road intersection with a measure ADT count of 25,000 vehicles or more on the main roadway and 15,000 vehicles or more on any intersection roadway, excluding project proposing primarily pedestrian or bicycle use improvements.

The oil control requirement for high-use sites applies to all sites that generate high concentrations of oil, regardless of whether the project creates new impervious surface or makes site improvements to an existing high-use site. The traffic threshold identified focuses on vehicle turnover per square foot of building area (trip generation) rather than ADT alone. This is because oil leakage is greatest when engines are idling or cooling. In general, all-day parking areas are not intended to be captured by these thresholds except for diesel vehicles, which tend to leak oil more than non-diesel vehicles. The petroleum storage and transfer stipulation is intended to address regular transfer operations such as service stations, not occasional filling of heating oil tanks.

Threshold	Requirement
<p>IF a proposed project either:</p> <ul style="list-style-type: none"> • develops a site that will have high-use site characteristics (defined above), OR • is a redevelopment project proposing \$100,000 or more of improvements to an existing high-use site. • is a redevelopment project that results in new plus replaced pollution generating impervious surfaces of 5,000 square feet or more or new pollution generating pervious surfaces of $\frac{3}{4}$ acre or more improvements to an existing high-use site... 	<p>THEN the project must treat runoff from the high-use portion of the site using oil control treatment options from the High-Use menu (described below and detailed in Chapter 6).</p>

High-Use Menu

High-use oil control options are selected to capture and detain oil and associated pollutants. The goal of treatment is to have no visible sheen in runoff leaving the facility, or to have less than 10 mg/L total petroleum hydrocarbons (TPH), depending on the facility option used. Oil control options include facilities that are small, handle only a limited tributary area, and require frequent maintenance, as well as facilities that treat larger areas and generally have less frequent maintenance needs. Facility choices include catch basin inserts, linear sand filters, and oil/water separators. See Chapter 6 for specific facility choices and design details.

Application of this Requirement

For *high-use sites* located within a larger commercial center, only the impervious surface associated with the high-use portion of the *site* is subject to treatment requirements. If common parking for multiple businesses is provided, treatment shall be applied to the number of parking stalls required for the high-use business only. However, if the treatment collection area also receives runoff from other areas, the water quality facility must be sized to treat all water passing through it.

High-use roadway intersections shall treat the intersection itself, plus lanes where vehicles accumulate during the signal cycle, including all lanes, from the beginning of the left-turn pocket (see Figure 1.3.5.A below). If no left-turn pocket exists, the treatable area shall begin at a distance of 75 feet from the stop line. If runoff from the intersection drains to more than two collection areas that do not combine within the intersection, treatment may be limited to any two of the collection areas. Oil control facilities shall be designed for all flows tributary to the oil control facility including flow from otherwise exempt areas that are not bypassed around the facility.

Note: For oil control facilities to be located in public road right-of-way and maintained by Kent, only coalescing plate or baffle oil/water separators shall be used unless otherwise approved by an adjustment. *Catch basin inserts are not allowed for oil control.*

Methods of Analysis

The traffic threshold for the High-Use menu shall be estimated using information from *Trip Generation*, published by the Institute of Transportation Engineers, or from a traffic study prepared by a professional engineer or transportation specialist with experience in traffic estimation.

FIGURE 1.3.5.A TREATABLE AREAS FOR HIGH-USE ROAD INTERSECTIONS

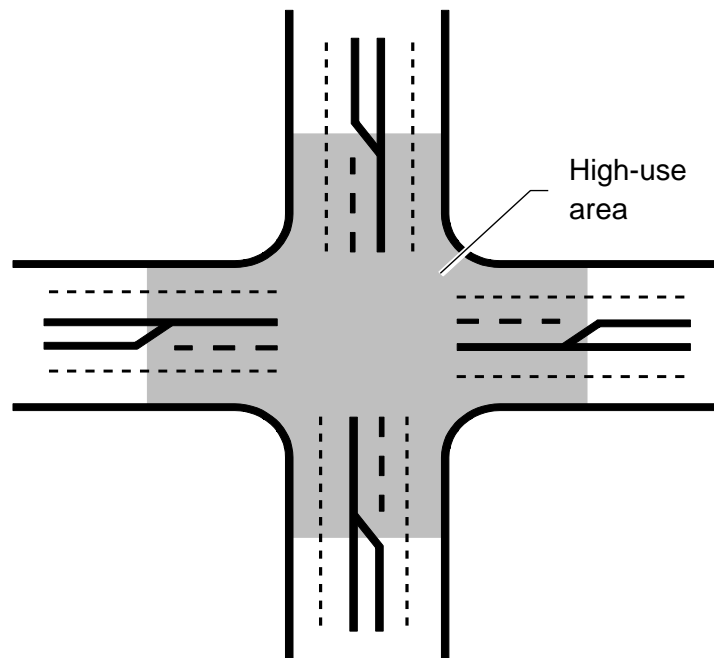

1.4 ADJUSTMENT PROCESS

For proposed projects subject to drainage review by city review staff, this process is provided for the occasions when a project proponent desires to vary from one of the core or special requirements, or any other specific requirement or standard contained in this manual. Proposed adjustments should be approved prior to final permit approval, but they may be accepted up to the time Kent approves final construction or accepts drainage facilities for maintenance.

Types of Adjustments

To facilitate the adjustment process and timely review of adjustment proposals, the following types of adjustments are provided:

- * **Standard Adjustments:** These are adjustments of the standards and requirements contained in the following chapters and sections of this manual:
 - * Chapter 1, "Drainage Review and Requirements"
 - * Chapter 2, "Drainage Plan Submittal"
 - * Chapter 3, "Hydrologic Analysis and Design"
 - * Chapter 4, "Conveyance System Analysis and Design"
 - * Chapter 5, "Flow Control Design"
 - * Chapter 6, "Water Quality Design"
 - * Appendix A, "Maintenance Requirements for Flow Control, Conveyance, and WQ Facilities"
 - * Appendix B, "Master Drainage Plans."
 - * Appendix C, "Simplified Drainage Requirements" (detached)
 - * Appendix D, "Construction Stormwater Pollution Prevention Standards" (detached).

Requests for standard adjustments will be accepted only for permits pending approval or approved permits that have not yet expired.

- * **Experimental Design Adjustments:** This type of adjustment is used for proposing new designs or methods that are not covered in this manual, that are not uniquely *site* specific, and that require additional information to establish functional equivalence.
- * **Blanket Adjustments:** This type of adjustment may be established by the City based on approval of any of the above-mentioned adjustments. Blanket adjustments are usually based on previously approved adjustments that can be applied routinely or globally to all projects where appropriate. Blanket adjustments are also used to effect minor changes or corrections to manual design requirements or to add new designs and methodologies to this manual. There is no application process for establishing blanket adjustments because they are initiated solely by the City.

1.4.1 ADJUSTMENT AUTHORITY

The Economic and Community Development Department shall have full authority to approve or deny all types of adjustments for any proposed project subject to drainage review by city review staff.

1.4.2 CRITERIA FOR GRANTING ADJUSTMENTS

Adjustments to the requirements in this manual may be granted provided that granting the adjustment will achieve the following:

1. Produce a compensating or comparable result that is in the public interest, AND
2. Meet the objectives of safety, function, appearance, environmental protection, and maintainability based on sound engineering judgment.

Granting any adjustment that would be in conflict with the requirements of any other Kent department will require review and concurrence with that department.

Criteria Exception

If it can be demonstrated that meeting the above criteria for producing a compensating or comparable result will deny reasonable use of a property, approval of the adjustment will require an adjustment **criteria exception** to be approved by the Economic and Community Development Director (whoever is approving the adjustment). An adjustment that requires a criteria exception may be granted following legal public notice of the adjustment request, the director's proposed decision on the request, and a written finding of fact that documents the following:

1. There are special physical circumstances or conditions affecting the property such that strict application of the criteria for producing a compensating or comparable result would deprive the applicant of all reasonable use of the parcel of land in question, and every effort has been made to find creative ways to meet the intent of the requirement for which the adjustment is sought, AND
2. Granting the adjustment for the individual property in question will not create a significant adverse impact to public health, welfare, water quality, and properties downstream or nearby, AND
3. The adjustment requires the best practicable alternative for achieving the spirit and intent of the requirement in question.

In addition, the written finding of fact must include the following information:

- The current (pre-project) use of the *site*.
- How application of the requirement for which an adjustment is being requested denies reasonable use of the *site* compared to the restrictions that existed under the 2009 *Surface Water Design Manual*.
- The possible remaining uses of the *site* if the criteria exception were not granted.
- The uses of the *site* that would have been allowed under the 2009 *Surface Water Design Manual*.
- A comparison of the estimated amount and percentage of value loss as a result of the requirements of this manual versus the estimated amount and percentage of value loss as a result of requirements that existed under the 2009 *Surface Water Design Manual*.
- The feasibility for the owner to alter the project to apply the requirements of this manual.

Experimental Design Adjustments

Experimental design adjustments may be required for departures from design specifications in flow control facilities (Chapter 5), may be required for alternatives to erosion and sediment control (ESC) facilities in Appendix D; and are required for alternatives to water quality facilities listed in Chapter 6 and Reference 14. Required water quality monitoring is in addition to any required by Ecology for their approval. Kent does not pay for this monitoring. Monitoring costs are covered by the applicant and/or the facility vendor or manufacturer according to their agreement.

Flow Control Facilities

In most cases, a standard adjustment applies to alternative flow control designs. However, city review staff may require an experimental design adjustment that includes monitoring when deemed warranted.

Erosion and Sediment Control Facilities

Erosion and sediment control (ESC) facilities that have Ecology CTAPE approval do not require an experimental design adjustment. The City of Kent will consider an experimental design adjustment for an ESC without CTAPE approval, but only for those that Ecology has approved as equivalent.

Water Quality Facilities

Experimental design adjustments for water quality facilities may be approved by city review staff on a limited basis if, upon evaluation, city review staff determines the following criteria are met:

- The facility has already been approved by Ecology's TAPE³⁰³¹ program, and has General Use Level Designation (GULD). Facilities with conditional approval (CULD) may also be considered if the manufacturer has applied to Ecology for GULD determination and will be monitoring under the TAPE program. Approval by Ecology does not by itself constitute or ensure approval by the City of Kent. For both GULD and CULD designations, Ecology's approval documentation must indicate that maintenance is required no more frequently than annually for flow control and water quality facilities excluding temporary construction ESC facilities.
- Experimental design adjustments are not permitted for facilities that the city will be responsible to maintain.
- City review staff determines that technical reports and data suggest facility performance could be replicated. City review staff must have access to the full technical report(s) submitted to Ecology for TAPE, and may require any other reports or data referred to but not provided.
- The Applicant agrees to monitoring as described in Reference 8-F; a monitoring quality assurance project plan has been submitted to, reviewed and approved by city review staff; and the Consultant providing the monitoring has provided the Applicant and city review staff with a cost analysis of the monitoring program.
- For Presettling and Basic treatment water quality facilities only, if the facility has already been approved by Ecology through Ecology's TAPE program, and has GULD, additional TSS percent removal monitoring will not be required, but city review staff may require other monitoring, e.g., constructability, durability, and/or maintenance monitoring. City review staff may limit the number of installations until he/she is satisfied that the facility type is viable.

Additional Notes

- If review of Ecology's basis for granting GULD is found to be flawed and city review staff then finds GULD should not have been issued, city review staff may rescind its approval for new installations of the facility in the City of Kent.
- An experimental adjustment for ESC does not absolve the Applicant from meeting the requirements of 1.2.5.2. C, ESC Performance.
- Conditions for approval of experimental design adjustments may include a requirement for setting aside an extra area and posting a financial guarantee for construction of a conventional facility

³⁰ Technology Assessment Protocol – Ecology

should the experimental facility fail to perform adequately. Once satisfactory durability, operation, and performance of the experimental facility are verified, the set aside area could be developed and the financial guarantee released.

- The number of experimental installations of any one kind will normally be limited to two, until the City of Kent has obtained sufficient evidence indicating performance meets criteria.

1.4.3 ADJUSTMENT APPLICATION PROCESS

Adjustment Application Form

The adjustment application form for standard and experimental design adjustments can be obtained from plan review staff.

Standard Adjustments

The application process for standard adjustments is as follows:

- * Requests for standard adjustments will be accepted only for permits pending approval or approved permits that have not yet expired.
- * The completed adjustment request application forms must be submitted to city review staff along with sufficient engineering information (described in Chapter 2) to evaluate the request. The application shall note the specific requirement for which the adjustment is sought.
- * If the adjustment request involves use of a previously unapproved construction material or construction practice, the applicant should submit documentation that includes, but is not limited to, a record of successful use by other agencies and/or evidence of meeting criteria for quality and performance, such as that for the American Association of State Highway and Transportation Officials (AASHTO) and the American Society of Testing and Materials (ASTM).
- * If the adjustment requires a criteria exception, additional engineering or other information may be required by city review staff to document that denial of reasonable use would occur, that every effort was made to achieve compliance, and that the best practicable alternative will not cause significant adverse impact.
- * A fee reduction may be requested if it is demonstrated that the adjustment request requires little or no engineering review.

Experimental Design Adjustments

The application process is the same as for standard adjustments except that requests will be accepted prior to permit application. Justification supporting comparable performance of the proposed system to a standard design is required.

Blanket Adjustments

There is no application process for establishing blanket adjustments because they are initiated and issued solely by the City.

Applicants may apply to use SWDM web-posted blanket adjustments by submitting the adjustment application form noted above to plan review staff assigned to the specific project proposal.

1.4.4 ADJUSTMENT REVIEW PROCESS

The general steps of the review process for specific types of adjustments are presented as follows:

Standard Adjustments

- * City review staff will review the adjustment request application forms and documentation for completeness and inform the applicant in writing as to whether additional information is required from the applicant to complete the review. The applicant will also be informed if city review staff determines that special technical support is required in cases where the adjustment involves a major policy issue or potentially impacts a Public Works drainage facility.

- * The Economic and Community Development Director or designee will review and either approve or deny the adjustment request following city review staff's determination that all necessary information has been received from the applicant.
- * If a criteria exception is required for the adjustment, city review staff will issue a legal public notice of the adjustment request that indicates the director's proposed decision on the request, including the written finding of fact specified in Section 1.4.2. The public notice will include a 15-working-day public comment period within which a request for reconsideration may be made to the Economic and Community Development Director as described in Section 1.4.5. Absent a request for reconsideration, the Director's decision becomes final after the two week public comment period.
- * Approvals of standard adjustments will expire upon expiration of the permit to which they apply.

Experimental Design Adjustments

- The City will consider any flow control adjustment request, but will only consider experimental design adjustments for water quality facilities that have been approved by Ecology's TAPE program, and erosion and sediment control facilities that have been deemed by Ecology to be equivalent to facilities they have approved through their CTAPE program.
- All information including but not limited to reports and data submitted to Ecology for their TAPE approvals must be submitted to City plan review staff. This may require coordination between the manufacturer and the applicant.
- City review staff will review the submitted material and any recommendations, and inform the review staff will also give the applicant an estimate of the time needed to complete the review. There is no guarantee that an experimental adjustment will be granted.
- If a criteria exception is required for the adjustment, city review staff will issue a legal public notice of the adjustment request that indicates city review staff's proposed decision on the request, including the written finding of fact specified in Section 1.4.2. The public notice will include a 15-working-day public comment period within which a request for reconsideration may be made to the Economic and Community Development Director as described in Section 1.4.5. Absent a request for reconsideration, the Director's decision becomes final after the 15-working-day public comment period.
- The Economic and Community Development Director or designee will review and either approve or deny the adjustment request in writing, and this will in turn be communicated to the Applicant by city review staff in writing.

Blanket Adjustments

Blanket adjustments will be established at the discretion of city review staff based on:

1. A previously approved standard or experimental design adjustment and supporting documentation, AND
2. Experimental adjustment monitoring results in conjunction with any TAPE or CTAPE results AND
3. Information presenting the need for the blanket adjustment. Typically, blanket adjustments should apply globally to design or procedural requirements and be independent of *site* conditions.

1.4.5 REQUEST FOR RECONSIDERATION PROCEDURE

The applicant may request reconsideration of the denial or conditions of approval of an adjustment request by submitting a formal letter to the Economic and Community Development Director within 15 working days of the decision. This letter must include justification for review of the decision, along with a copy of the adjustment request with the conditions (if applicable) and a listing of all previously submitted material. The Economic and Community Development Director shall respond to the applicant in writing within 15 working days; this decision shall be final. A per-hour review fee will be charged to the applicant for City review of an appeal.

Criteria Exceptions

A criteria exception decision for an adjustment is a Process 1 land use decision pursuant to Chapter 12.01 KCC. Because the public is given an opportunity to comment on a criteria exception decision, the applicant may request reconsideration of the decision by submitting a formal letter to the Director within 15 working days of the legal public notice. This letter must include justification for reconsideration of the decision, along with any supporting information/documentation. The Director shall respond to the letter in writing within 15 working days. The Director's decision on the reconsideration request shall be final.

CHAPTER 2

DRAINAGE PLAN SUBMITTAL



CITY OF KENT

Surface Water Design Manual

2021

CHAPTER 2

Drainage Plan Submittal	2-1
2.1 Plans for Permits and Drainage Review.....	2-2
2.1.1 Plans Required for initial permit Submittal	2-2
2.1.2 Plans Required for drainage review	2-2
2.2 Plans Required with Initial permit submittal	2-4
2.2.1 Subdivisions, short plats and Binding site plans.....	2-4
2.2.2 Commercial Site Development.....	2-6
2.2.3 Single-family Residential	2-6
2.2.4 Other Permits	2-6
2.3 Plans Required for Drainage Review	2-7
2.3.1 Engineering Plan Specifications	2-7
2.3.2 Projects in Targeted Drainage Review	2-32
2.4 Plans Required After Drainage Review	2-34
2.4.1 Plan Changes After Permit Issuance.....	2-34
2.4.2 Final Corrected Plan Submittal.....	2-34
2.4.3 Final Plat, Short Plat, and Binding Site Plan Submittals	2-34

2 DRAINAGE PLAN SUBMITTAL

A completely revised Chapter 2 is provided below. It is to be used instead of Chapter 2 of the 2016 King County Surface Water Design Manual for all proposals in the city of Kent.

This chapter details the drainage related submittal requirements for engineering design plans as part of a permit application to the Kent Economic and Community Development Department. The intent of these requirements is to present consistent formats for design plans and the technical support data required to develop the plans. These conventions are necessary to review engineering designs for compliance with Kent ordinances and regulations, and to ensure the intent of the plan is easily understood and implemented in the field. Properly drafted design plans and supporting information also facilitate the construction, operation, and maintenance of the proposed system long after its review and approval. When plans comply with the formats and specifications contained herein, they facilitate review and approval with a minimum of time-consuming corrections and resubmittals.

Note that this chapter primarily describes how to submit drainage plans for review—what must be submitted, in what formats, at what times, and to what offices. The basic drainage requirements that these plans must address are contained in Chapter 1, “Drainage Review and Requirements.” The specific design methods and criteria to be used are contained in Chapters 3, 4, 5, and 6.

Several key forms used in the plan review process are reproduced in Reference Section 8, “Plan Review Forms and Worksheets” accompanying Chapter 5 of the Kent Construction Standards.

Chapter Organization

The information presented in this chapter is organized into four main sections as follows:

- Section 2.1, “Plans for Permits and Drainage Review”
- Section 2.2, “Plans Required with Initial Permit Application”
- Section 2.3, “Plans Required for Drainage Review”
- Section 2.4, “Plans Required After Drainage Review”

These sections begin on odd pages so that tabs can be inserted by the user if desired for quicker reference.

2.1 PLANS FOR PERMITS AND DRAINAGE REVIEW

The Economic and Community Development Department is responsible for the review of all engineering aspects of private development proposals. Drainage review is a primary concern of engineering design. This section provides an overview of the **types of engineered drainage plans** required for engineering review at various permit review stages. Detailed requirements are presented in Sections 2.2 and 2.3.

2.1.1 PLANS REQUIRED FOR INITIAL PERMIT SUBMITTAL

Most projects require some degree of drainage plans or analysis to be submitted with the initial permit application (see Table 2.2.1.A). At the City of Kent, subdivisions and short plats are reviewed in two stages: preliminary and final. Subdivisions and short plats will require a “**Preliminary Plat/Short Plat Drainage Package**” with the initial permit application. The package will provide general information on the proposal, including location of environmentally sensitive areas, road alignments and right-of-way, *site* topography, building locations, land use information, and lot dimensions. It will be used to determine the appropriate drainage conditions and requirements to be applied to the proposal during the drainage review process.

Single-family residential building permits require only a site plan with the initial permit application. Commercial permits require full **engineering plans** (see below). Other permits may have project specific drainage requirements determined by the Economic and Community Development Department.

2.1.2 PLANS REQUIRED FOR DRAINAGE REVIEW

For drainage review purposes, **engineering plans** consist of the following:

1. **Site improvement plans**, which include all plans, profiles, details, notes, and specifications necessary to construct road, drainage, and off-street parking improvements (see Section 2.3.1.2).
2. A **technical information report (TIR)**, which contains all the technical information and analysis necessary to develop the site improvement plan and CSWPP plan. (see Section 2.3.1.1).
3. A **construction stormwater pollution prevention (CSWPP) plan, which identifies the measures and BMP’s required to prevent the discharge of sediment-laden water and other pollutants associated with construction/land disturbing activities. The CSWPP plan includes two component plans: an erosion and sediment control (ESC) plan (see Section 2.3.1.3), which addresses prevention of sediment-laden discharges; and stormwater pollution prevention and spill (SWPPS) plan (see Section 2.3.1.4), which addresses prevention of other pollutant discharges.**

Note: A landscape management plan is also included if applicable (see Section 2.3.1.5).

Projects under Targeted Drainage Review usually require engineering plans, except that only certain sections of the technical information report are required to be completed and the site improvement plan may have a limited scope depending upon the characteristics of the proposed project. The scope of these plans should be confirmed during the **project pre-application meeting** with the Economic and Community Development Department. For other permits, such as single-family residential permits, the scope of the targeted engineering analysis is usually determined during Economic and Community Development Department engineering review.

Projects without major drainage improvements may be approved to submit a *modified site improvement plan*. Major drainage improvements usually include water quality or flow control facilities, conveyance systems, bridges, and road right-of-way improvements. For projects requiring engineering plans for road construction, a **modified site improvement plan** is not allowed. See Section 2.3.1.2 for further information.

Plans Required for Simplified Drainage Review

Simplified drainage plans are a simplified form of site improvement and CSWPP plans (without a TIR or a separate SWPPS plan), that may be prepared by a non-engineer from a set of pre-engineered design details. Simplified drainage plans are only allowed for single family or agricultural projects in Simplified Drainage Review but may be required for individual lots created by a subdivision project to show how required flow control BMPs, ESC, and SWPPS measures will be applied to future lot construction.

For single-family residential permits, the level and scope of drainage plan requirements are determined by the Economic and Community Development Department during drainage review. Some projects qualifying for Simplified Drainage Review may also require Targeted Drainage Review.

TABLE 2.1.2.B DRAINAGE PLAN SUBMITTALS

Type of Permit or Project	Plans Required with Initial Land Use Permit Application	Type of Drainage Review ⁽⁵⁾	Plans Required for Building Permit Drainage Review
SUBDIVISIONS AND SHORT PLATS*	Preliminary Plat ⁽¹⁾ /Short Plat Drainage Package: - Conceptual Drainage Plan - Level 1 Downstream Analysis - Survey/Topographic Information	Full or Targeted Drainage Review ⁽²⁾	<ul style="list-style-type: none"> • Preliminary Plat/Short Plat Drainage Package⁽¹⁾ • Engineering Plans⁽³⁾
COMMERCIAL	Engineering Plans ^{(2),(3)}	Full or Targeted Drainage Review	Engineering Plans ⁽³⁾
SINGLE-FAMILY RESIDENTIAL BUILDING PERMITS OR PERMITS FOR AGRICULTURAL PROJECTS	Conceptual Drainage Plan ⁽¹⁾	Simplified Drainage Review OR	Simplified Drainage Plans ⁽⁴⁾
		Simplified Drainage Review AND Targeted Drainage Review ⁽²⁾ OR	<ul style="list-style-type: none"> • Simplified Drainage Plans⁽⁴⁾ • Engineering Plans⁽³⁾
		Full or Targeted Drainage Review ⁽²⁾	Engineering Plans ⁽³⁾
OTHER PROJECTS OR PERMITS	Project-specific (contact the Economic and Community Development Department)	Full or Targeted Drainage Review ⁽²⁾	Engineering Plans ⁽³⁾

Notes:

- (1) Submittal specifications for these plans are found in the application packages.
 - (2) Submittal specifications for **Targeted Drainage Review** are found in Section 2.3.2.
 - (3) Submittal specifications for **engineering plans** are detailed in Section 2.3.1.
 - (4) Specifications for submittal of **Simplified drainage plans** are found in Appendix C of the King County Manual, *Simplified Drainage Requirements* (detached).
 - (5) Refer to Chapter 1, Table 1.1.2.A for definitions of the different drainage review types.
- * Short plats meeting the thresholds defining small sites may go through the Simplified drainage review process.

2.2 PLANS REQUIRED WITH INITIAL PERMIT SUBMITTAL

This section describes the submittal requirements for initial permit applications at the City of Kent. The **timing for submittal** of engineering plans will vary depending on permit type. For subdivisions and short plats, this submittal usually follows the City's approval of the *Preliminary Plat/Short Plat Drainage Package*. For commercial building permits, engineering plans must be submitted as part of the initial permit application. For other permit types the drainage plan requirements are determined during the permit review process.

Note: If engineering plans are required to be submitted with the initial permit application, they must be accompanied by the appropriate supporting documents (e.g., required application forms, an environmental checklist, etc.). For more details, see Reference Section 8.

Design Plan Certification

All preliminary plat/short plat drainage packages and engineering plans **must be stamped** by a licensed civil engineer registered in the State of Washington.

All land boundary surveys and legal descriptions used for preliminary and engineering plans must be stamped by a professional land surveyor registered in the State of Washington. Topographic survey data and mapping prepared specifically for a proposed project may be performed by the licensed civil engineer stamping the engineering plans as allowed by the Washington State Board of Registration for Professional Engineers and Land Surveyors.

2.2.1 SUBDIVISIONS, SHORT PLATS AND BINDING SITE PLANS

Applications for preliminary subdivisions and short plats must include a *preliminary plat/short plat drainage package* consisting of the following:

1. A **Conceptual Drainage Plan** prepared, stamped, and signed by a licensed civil engineer registered in the State of Washington. This plan must show the following:

The level of detail of the plan should correspond to the complexity of the project.

Plans submitted for review shall contain the following information at a minimum:

- a) A brief narrative describing existing and proposed *site* conditions, including inventoried or delineated wetlands, streams, ponds, lakes, rivers, steep or unstable slopes, erosion hazard areas and landslide hazard areas. Include a description of the existing use of the *site* and the proposed use of the *site* after development.
- b) Two simple drainage plans are required for a *Conceptual Drainage Plan*: an existing condition drainage plan and post-development drainage plan.
- c) Both drainage plans must be drawn to an engineering scale (i.e. 1" = 20', or 1" = 30', for example, not 1/8" = 1'), and must contain a north arrow. NOTE: North arrows shall either point to the top of the page or to the right side of the page only.
- d) Include a vicinity map, which clearly shows the location of the development parcel with respect to public streets and other parcels and developments.
- e) Drainage plans shall include property lines, including line lengths (bearings of property lines are preferred, but not required).
- f) All public and private roads, driveway accesses and road easements, with dimensions. All manmade or natural features (streams, rivers, drainage ditches, railroad tracks, hills, depressions, structures of all kinds, steep slopes, ponds, lakes, etc.) and the existing direction of surface water flows shown by arrows pointing in the direction of flow.

- g) Setback dimensions from all property lines and from sensitive areas such as wetlands, streams, steep or unstable slopes, and Native Growth Protection Tracts.
 - h) Existing and proposed building and landscape locations.
 - i) Differentiate between developed portions of a parcel, and undeveloped / natural areas of a parcel, and areas set aside for future development.
 - j) Outside storage areas and types of surfaces for storage areas.
 - k) The post-development drainage plan shall include a proposed conveyance system layout, and the location of discharge points onto and off of the property; the total amount of impervious surface created (including rooftops); the approximate building and parking lot / storage yard footprints; and all proposed stormwater treatment, and proposed locations for stormwater management Best Management Practices (detention ponds, biofiltration swales, oil / water separators, etc.).
 - l) A legal description for the property and the Assessor's Tax Lot Number for the property.
 - m) The name, address, and telephone number of the person preparing the Site Plan.
 - n) The location and type of existing and proposed flow control facilities, water quality facilities and conveyance systems clearly marked individually as public or private to designate ownership and maintenance responsibilities in accordance with the plat agreement.
2. **A Level 1 Downstream Analysis** as required in Core Requirement #2 and outlined under “TIR Section 3, Offsite Analysis.” The Level 1 Downstream Analysis is required for all short plats except those meeting the exemptions outlined in Section 1.2.2 or qualifying for Simplified Drainage Review for the entire project. This offsite analysis shall be submitted to assess potential offsite drainage impacts associated with development of the project, and to help propose appropriate mitigation of those impacts. A higher level of offsite analysis may be requested by the Economic and Community Development Department prior to preliminary approval, or as a condition of engineering plan submittal. The offsite analysis must be prepared, stamped, and signed by a licensed civil engineer registered in the State of Washington.
3. **Survey/topographic information.** The submitted *site* plan and conceptual drainage plan shall include:
- a) Field topographic base map to accompany application (aerial topography allowed with city of Kent permission)
 - b) Name and address of surveyor and surveyor's seal and signature
 - c) Notation for field or aerial survey
 - d) Datum and benchmark/location and basis of elevation
 - e) Location of all streams, lakes, wetlands, closed depressions, or Hazard Areas (include any corresponding King County or Kent designation number, or identify as undesignated)
 - f) Contour intervals per the following chart:

Zoning Designation	Contour Intervals
Densities of developed area of over 2 DU per acre	2 feet at less than 15% slope 5 feet at 15% slope or more
Densities of developed area of 2 DU or less per acre	5 feet

2.2.2 COMMERCIAL SITE DEVELOPMENT

Applications for commercial permits require that **engineering plans** be submitted as part of the initial permit application. Most commercial projects will go through Full Drainage Review and require complete engineering plans. Projects which may qualify for limited scope engineering design should request Targeted Drainage Review during the Pre-Application meeting with the Economic and Community Development Department.

2.2.3 SINGLE-FAMILY RESIDENTIAL

Applications for single-family residential permits require a non-engineered **site plan** to be submitted. Refer to the minimum requirements listed at the beginning of Section 2.3 (see detached Appendix C, Section C.5.1),

2.2.4 OTHER PERMITS

Other permit applications will require project-specific information. Initial submittal requirements can be obtained by contacting the Economic and Community Development Department.

2.3 PLANS REQUIRED FOR DRAINAGE REVIEW

This section presents the specifications and contents required of plans to facilitate drainage review. Most projects subject to **Full Drainage Review** will require **engineering plans** that include a **technical information report (TIR)**, **site improvement plans**, and a "construction stormwater pollution prevention (CSWPP) plan," which includes an "erosion and sediment control (ESC) plan" and a "stormwater pollution prevention and spill (SWPPS) plan." In addition, a **landscape management plan** may also be required to comply with Core Requirement #8 (see Section 1.2.8). For more information on the types of projects subject to Full Drainage Review, see Section 1.1.2.3.

Small projects with specific drainage concerns that are subject to **Targeted Drainage Review** also require engineering plans that include the same elements, except that the TIR may be of limited scope. The site improvement plans and ESC plans may also be of limited scope, but must meet all applicable specifications. For more information on the types of projects subject to Targeted Drainage Review, see Section 1.1.2.2.

Projects that qualify for **Simplified Drainage Review** may be required to submit simplified drainage plans. These are simplified drainage and erosion control plans that can be prepared by a non-engineer from a set of pre-engineered design details, and do not require a TIR. The *Simplified Drainage Requirements* booklet available at the King County Department of Permitting and Environmental Review and appended to the King County Manual (detached Appendix C, Section C.5.1) contains the specifications for simplified drainage plans and details on the Simplified Drainage Review process.

Note: Projects in Simplified Drainage Review may be required to submit engineering plans if they are also subject to Targeted Drainage Review as determined in Section 1.1.2.2 and Appendix C of the King County Manual. Also, short plats in Simplified Drainage Review will be required to submit engineering plans if roadway construction is a condition of preliminary approval.

Design Plan Certification

All preliminary plat/short plat drainage packages and engineering plans must be **stamped by a licensed civil engineer** registered in the State of Washington.

All land boundary surveys and legal descriptions used for preliminary and engineering plans must be **stamped by a professional land surveyor** registered in the State of Washington. Topographic survey data and mapping prepared specifically for a proposed project may be performed by the licensed civil engineer stamping the engineering plans as allowed by the Washington State Board of Registration for Professional Engineers and Land Surveyors.

2.3.1 ENGINEERING PLAN SPECIFICATIONS

For drainage review purposes, engineering plans must consist of:

1. A **technical information report (TIR)** as detailed in Section 2.3.1.1, AND
2. **Site improvement plans** as detailed in Section, 2.3.1.2 AND
3. A **CSWPP plan, which includes an ESC plan** as detailed in Section 2.3.1.3 and a SWPPS plan as detailed in Section 2.3.1.4.

Also, if applicable per Section 1.2.8, a **landscape management plan**, as detailed in Section 2.3.1.5, must be included.

Projects in Targeted Drainage Review require a limited scope TIR with site improvement plans and a CSWPP plan, as detailed in Section 2.3.2. The Economic and Community Development Department may allow a **modified site improvement plan** for some projects in Targeted Drainage Review (see Section 2.3.2) or where major improvements (e.g., detention facilities, conveyance systems, bridges, road right-of-way improvements, etc.) are not proposed.

2.3.1.1 TECHNICAL INFORMATION REPORT (TIR)

The full **TIR** should be a comprehensive supplemental report containing all technical information and analysis necessary to develop the site improvement plan. This report should contain all calculations, conceptual design analysis, reports, and studies required and used to construct a complete site improvement plan based on sound engineering practices and careful geotechnical and hydrological design. The TIR must be stamped and dated by a licensed civil engineer registered in the State of Washington.

The TIR shall contain the following **ten sections**, preceded by a table of contents:

1. Project Overview
2. Conditions and Requirements Summary
3. Offsite Analysis
4. Flow Control and Water Quality Facility Analysis and Design
5. Conveyance System Analysis and Design
6. Special Reports and Studies
7. Other Permits
8. CSWPP Analysis and Design
9. Bond Quantities, Facility Summaries, and Declaration of Covenant
10. Operations and Maintenance Manual

Every TIR must contain each of these sections; however, if a section does not apply, the applicant may simply mark “N/A” with a brief explanation shall be provided. This standardized format allows a quicker, more efficient review of information required to supplement the site improvement plan.

The **table of contents** should include a list of the ten section headings and their respective page numbers, a list of tables with page numbers, and a list of numbered references, attachments, and appendices.

When the TIR package requires revisions, the **revisions** must be submitted in a complete TIR package.

❑ TIR SECTION 1 PROJECT OVERVIEW

The project overview must provide a general description of the proposal, predeveloped and developed conditions of the *site, site* area and size of the improvements, and the disposition of stormwater runoff before and after development. The overview shall identify and discuss difficult *site* parameters, the natural drainage system, and drainage to and from adjacent property, including bypass flows.

The following figures are required:

Figure 1. TIR Worksheet

Include a copy of the TIR Worksheet (see Reference Section 8-A).

Figure 2. Site Location

Provide a map that shows the general location of the *site*. Identify all roads that border the *site* and all significant geographic features including all streams, lakes, wetlands, closed depressions, and Hazard Areas.

Figure 3. Drainage Basins, Subbasins, and Site Characteristics

This figure shall display:

1. Acreage of all subbasins
2. All *site* characteristics
3. Existing discharge points to and from the site

4. Routes of existing, construction, and future flows at all discharge points and downstream hydraulic structures
5. A minimum City of Kent Storm Sewer Facility Map, 1" = 300' as a base for the figure (available at the Kent Permit Center)
6. The length of travel (also cite) from the farthest upstream end of a proposed storm system in the development to any proposed flow control facility

Figure 4. Soils

Show the soils within the following areas:

1. The *project site*
2. The area draining to the *site*
3. The drainage system downstream of the *site* for the distance of the downstream analysis (see Section 1.2.2)

Copies of King County Soil Survey **maps** may be used; however, if the maps do not accurately represent the soils for a proposed project (including offsite areas of concern), it is the design engineer's responsibility to ensure that the actual soil types are properly mapped. Soil classification symbols that conform to the *SCS Soil Survey for King County* shall be used, and the equivalent KCRTS soil type (till, outwash, or wetlands) shall be indicated (see Table 3.2.2.B).

All plats and short plats (creating lots less than 22,000 square feet) must evaluate onsite soils for suitability of the full infiltration and other low impact flow control BMPs as specified in Core Requirement 9. This soils report, as well as geotechnical investigations necessary for proposed infiltration facilities, shall be referenced in the TIR Overview and submitted under Special Reports and Studies, TIR Section VI. A figure in the required geotechnical report that meets the above requirements may be referenced to satisfy 1, 2, and 3 above.

Projects located in outwash soils may need to provide a **low-permeability liner** or a **treatment liner** for water quality facilities and upstream conveyance ditches, consistent with the specifications for such liners in Section 6.2.4.

❑ TIR SECTION 2 CONDITIONS AND REQUIREMENTS SUMMARY

The intent of this section is to ensure all preliminary approval conditions and applicable requirements pertaining to *site* engineering issues have been addressed in the site improvement plan. All conditions and requirements for the proposed project should be included.

In addition to the core requirements of this manual, adopted basin plans and other plans as listed in Special Requirement #1 should be reviewed and applicable requirements noted. Sensitive area requirements³², conditions of plat approval, and conditions associated with development requirements (e.g., conditional use permits, rezones, variances and adjustments, SEPA mitigations, etc.) should also be included.

❑ TIR SECTION 3 OFFSITE ANALYSIS

All projects in engineering review shall complete, at a minimum, an Offsite Analysis, except for projects meeting the exemptions outlined in Section 1.2.2. The Offsite Analysis is usually completed as part of the initial permit application and review process and is to be included in the TIR. *Note: If offsite conditions*

³² Any specific regulations related to floodplains, streams, lakes, wetlands, closed depressions, or geologic hazard areas.

have been altered since the initial submittal, a new offsite analysis may be required.

The primary component of the offsite analysis is the **downstream analysis** described in detail below. Upstream areas are included in this component to the extent they are expected to be affected by backwater effects from the proposed project. Other components of the offsite analysis could include, but are not limited to, evaluation of impacts to fish habitat, groundwater levels, groundwater quality, or other environmental features expected to be significantly affected by the proposed project due to its size or proximity to such features.

Levels of Analysis

The offsite analysis report requirements vary depending on the specific *site* and downstream conditions. Each project submittal shall include at least a Level 1 downstream analysis. Upon review of the Level 1 analysis, the Economic and Community Development Department may require a Level 2 or Level 3 analysis. If conditions warrant, additional, more detailed analysis may be required. *Note: Potential impacts upstream of the proposal shall also be evaluated.*

Level 1 Analysis

The Level 1 analysis is a qualitative survey of each downstream system leaving a *site*. This analysis is required for all proposed projects and shall be submitted with the initial permit application. Depending on the findings of the Level 1 analysis, a Level 2 or 3 analysis may need to be completed or additional information may be required. If further analysis is required, the applicant may schedule a meeting with city review staff.

Level 2 or 3 Analysis

If drainage problems are identified in the Level 1 analysis, a Level 2 (rough quantitative) analysis or a Level 3 (more precise quantitative) analysis may be required to further evaluate proposed mitigation for the problem. City review staff will determine whether a Level 2 or 3 analysis is required based on the evidence of existing or potential problems identified in the Level 1 analysis and on the proposed design of onsite drainage facilities. The Level 3 analysis is required when results need to be as accurate as possible: for example, if the *site* is flat; if the system is affected by downstream controls; if minor changes in the drainage system could flood roads or buildings; or if the proposed project will contribute more than 15 percent of the total peak flow to the drainage problem location. The Level 2 or 3 analysis may not be required if city review staff determines from the Level 1 analysis that adequate mitigation can be developed.

Additional Analysis

Additional, more detailed hydrologic analysis may be required if city review staff determines that the downstream analysis has not been sufficient to accurately determine the impacts of a proposed project on an existing or potential drainage problem. This more detailed analysis may include a **point of compliance analysis** as detailed in Section 3.3.6.

Scope of Analysis

Regardless of the level of downstream analysis required, the applicant shall define and map the study area (Task 1), review resources (Task 2), inspect the study area (Task 3), describe the drainage system and problems (Task 4), and propose mitigation measures (Task 5) as described below.

Task 1. Study Area Definition and Maps

For the purposes of Task 2 below, the study area shall extend downstream one mile (minimum flow path distance) from the proposed project discharge location and shall extend upstream as necessary to encompass the offsite drainage area tributary to the proposed *project site*. **For the purposes of Tasks 3, 4, and 5**, the study area shall extend downstream to a point on the drainage system where the proposed *project site* constitutes a minimum of 15 percent of the total tributary drainage area, but not less than one-quarter mile (minimum flow path distance). The study area shall also extend upstream of the *project site* a distance sufficient to preclude any back water effects from the proposed project.

The offsite analysis shall include: (1) a **site map** showing property lines, and (2) the **best available topographical map** (e.g., at a minimum use the 1" = 300' City of Kent Storm Sewer Facility Maps available at the Kent Permit Center) with the study area boundaries, *site* boundaries, downstream flow

path, and potential/existing problems (Task 4) shown. Other maps, diagrams, and photographs such as aerial photographs may be helpful in describing the study area.

Task 2. Resource Review

To assist the design engineer in preparing an offsite analysis, the resources described below shall be reviewed as applicable for existing/potential problems in the study area (*upstream and one mile downstream of the project site*). Unless otherwise indicated, ask city of Kent review staff about the availability and applicability of these resources:

- Adopted basin plans
- Finalized drainage studies
- Basin Reconnaissance Summary Reports and 1"=400' scale problem summary maps (available at King County Department of Development and Environmental Services, King County Department of Natural Resources and the library)
- Floodplain/floodway (FEMA) maps
- Other offsite analysis reports in the same subbasin, if available
- Critical and Sensitive Area maps
- U.S. Department of Agriculture, *King County Soils Survey* (available at King County Department of Development and Environmental Services and the library)
- **Wetlands Inventory** maps (City-wide map included with this manual, detailed maps available at the Economic and Community Development Department)
- City of Kent **Erosion Hazard Area Map** and **Landslide Hazard Area Maps** (City-wide map included with this manual, detailed maps available at the Economic and Community Development Department)
- Washington State Department of Ecology's latest published Clean Water Act Section 303d list of polluted waters posted at the following website:
<http://www.ecy.wa.gov/programs/wq/303d/currentassessmt.html>.
- King County designated water quality problems listed and documented in the latest version of Reference Section 10 posted on King County's *Surface Water Design Manual* website. See also "Stormwater" on the iMap website: <http://www.kingcounty.gov/operations/gis/Maps/iMAP.aspx>.

Potential/existing problems identified in the above documents shall be documented in the **Drainage System Table** (see Reference Section 8-B) and described in the text of the **Level 1 Downstream Analysis Report**. If a document is not available for the site, note in the report that the information was not available as of a particular date. If necessary, additional resources are available from Kent, King County, the Washington State Department of Fisheries and Wildlife (WDFW), the State Department of Ecology (Ecology), and the United States Army Corps of Engineers (Corps).

Task 3. Field Inspection

The design engineer shall physically inspect the existing onsite and offsite drainage systems of the study area for each discharge location. Specifically, he/she shall investigate any evidence of the following existing or potential problems and drainage features:

Level 1 Inspection:

1. Investigate any problems reported or observed during the resource review.
2. Locate all existing/potential constrictions or lack of capacity in the existing drainage system.
3. Identify all existing/potential drainage problems as defined in Section 1.2.2.1.
4. Identify existing/potential overtopping, scouring, bank sloughing, or sedimentation.
5. Identify significant destruction of aquatic habitat or organisms (e.g., severe siltation, bank erosion, or incision in a stream).
6. Collect qualitative data on features such as land use, impervious surfaces, topography, and soil

types.

7. Collect information on pipe sizes, channel characteristics, drainage structures, and relevant critical areas (e.g., wetlands, streams, steep slopes).
8. Verify tributary basins delineated in Task 1.
9. Contact neighboring property owners or residents in the area about past or existing drainage problems, and describe these in the report (optional).
10. Note the date and weather conditions at the time of the inspection.

Level 2 or 3 Inspection:

1. Perform a Level 1 Inspection.
2. Document *existing site conditions* (approved drainage systems or pre-1979 aerial photographs) as defined in Core Requirement #3.
3. Collect quantitative field data. For Level 2, collect non-survey field data using hand tapes, hand reel, and rods; for Level 3, collect field survey profile and cross-section topographic data prepared by a licensed land surveyor.

Task 4. Drainage System Description and Problem Descriptions

Each drainage system component and problem shall be addressed in the offsite analysis report in three places: on a map (Task 1), in the narrative (Task 4), and in the *Offsite Analysis Drainage System Table* (see Reference Section 8-B).

Drainage System Descriptions: The following information about drainage system components such as pipes, culverts, bridges, outfalls, ponds, tanks, and vaults shall be included in the report:

1. Location (corresponding map label and distance downstream/upstream from *site* discharge)
2. Physical description (type, size, length, slope, vegetation, and land cover)
3. Problems including copies of any relevant drainage complaints
4. Field observations

Problem Descriptions: All existing or potential problems (e.g., ponding water, high/low flows, siltation, erosion, listed water bodies, etc.) identified in the resource review or field inspection shall be described in the offsite analysis. These descriptions will help in determining if such problems are one of three defined problem types that require special attention per Core Requirement #2 (see Section 1.2.2.1). Special attention may include more analysis, additional flow control, or other onsite or offsite mitigation measures as specified by the problem-specific mitigation requirements set forth in Section 1.2.2.2.

The following information shall be provided for each existing or potential **drainage problem**:

1. Description of the problem (ponding water, high or low flows, siltation, erosion, slides, etc.).
2. Magnitude of or damage caused by the problem (siltation of ponds, dried-up ornamental ponds, road inundation, flooded property, flooded building, flooded septic system, significant destruction of aquatic habitat or organisms).
3. General frequency and duration of problem (dates and times the problem occurred, if available).
4. Return frequency of storm or flow (cfs) of the water when the problem occurs (optional for Level 1 and required for Levels 2 and 3). *Note: A Level 2 or 3 analysis may be required to accurately identify the return frequency of a particular downstream problem; see Section 3.3.3.*
5. Water surface elevation when the problem occurs (e.g., elevation of building foundation, crest of roadway, elevation of septic drainfields, or wetland/stream high water mark).
6. Names and concerns of involved parties (optional for all levels of analysis).

7. Current mitigation of the drainage problem.
8. Possible cause of the drainage problem.

Whether the proposed project is likely to aggravate (increase the frequency or severity of) the existing problem or create a new one based on the above information. For example, an existing erosion problem should **not** be aggravated if Level 2 flow control is already required in the region for the design of onsite flow control facilities. Conversely, a downstream flooding problem inundating a home every 2 to 5 years will likely be aggravated if only Level 1 flow control is being applied in the region. See Section 1.2.3.1 for more details on the effectiveness of flow control standards in addressing downstream problems.

The following information shall be provided for each existing or potential **water quality problem**:

1. Description of the problem as documented by the State or City in the problem's listing. This should include the pollutant or pollutants of concern, the nature or category of the listing, and any other background information provided in the listing.
2. Flow path distance downstream of the *project site* and percentage of area draining to the problem that the *project site* occupies.
3. Possible or probable cause of the water quality problem.
4. Any current mitigation of the water quality problem.

Task 5. Mitigation of Existing or Potential Problems

For any existing or potential offsite **drainage problem** determined to be one of the three defined problem types in Section 1.2.2.1, the design engineer must demonstrate that the proposed project neither aggravates (if existing) nor creates the problem as specified in the drainage problem-specific mitigation requirements set forth in Section 1.2.2.2. The engineer must review each relevant drainage complaint found and include a narrative explaining how each complaint problem is addressed or mitigated. Actual copies of the relevant complaints must be included in the Analysis. To meet these requirements, the proposed project may need to provide additional onsite flow control as specified in Table 1.2.3.A (see also Section 3.3.5), or other onsite or offsite mitigation measures as described in Section 3.3.5.

For any existing or potential **water quality problem** determined to be one of the seven defined water quality problem types in Section 1.2.2.1, the design engineer must document how the applicable water quality problem-specific mitigation requirement in Section 1.2.2.3 will be met.

□ TIR SECTION 4 FLOW CONTROL, LOW IMPACT DEVELOPMENT (LID) AND WATER QUALITY FACILITY ANALYSIS AND DESIGN

Existing Site Hydrology (Part A)

This section of the TIR shall include a discussion of assumptions and *site* parameters used in analyzing the existing *site* hydrology. The definition of “existing site conditions” presented in Section 1.1 shall be applied for this section.

The acreage, soil types, and land covers used to determine existing flow characteristics, along with basin maps, graphics, and exhibits for each subbasin affected by the development, should be included.

The following information must be provided on a topographical map:

1. delineation and acreage of areas contributing runoff to the *site*
2. flow control facility and BMP location(s)
3. outfall location and description
4. overflow route(s)

The scale of the map and the contour intervals must be sufficient to determine the basin and subbasin boundaries accurately. The direction of flow, the acreage of areas contributing drainage, and the limits of development should all be indicated on the map.

Each subbasin contained within or flowing through the *site* shall be individually labeled and KCRTS parameters for the approved stormwater model referenced to that subbasin.

All natural streams and drainage features, including wetlands and depressions, must be shown. Rivers, closed depressions, streams, lakes, and wetlands must have the 100-year floodplain (and floodway where applicable) delineated as required in Special Requirement #2 (see Section 1.3.2) and by the critical areas requirements in KCC 11.06.

Developed Site Hydrology (Part B)

This section shall provide narrative, mathematical, and graphical presentations of parameters selected and values used for the developed *site* conditions, including acreage, soil types, land covers, roadway layouts, and all constructed drainage facilities and any required flow control BMPs.

Developed subbasin areas and flows shall be clearly depicted on a map and cross-referenced to computer printouts or calculation sheets. Relevant portions of the calculations shall be highlighted and tabulated in a listing of all developed subbasin flows.

All maps, exhibits, graphics, and references used to determine developed *site* hydrology must be included, maintaining the same subbasin labeling as used for the existing *site* hydrology whenever possible. If the boundaries of the subbasin have been modified under the developed condition, the labeling should be modified accordingly (e.g., Subbasin “Am” is a modified version of existing Subbasin “A”).

Performance Standards (Part C)

The design engineer shall include brief discussions of the following:

- The applicable **area-specific flow control facility standard** determined from the Flow Control Applications Map.
- Modifications to the standard to address onsite or offsite drainage conditions.
- Applicable **flow control BMP requirements** determined from Section 1.2.3.3 and Core Requirement 9.
- The applicable **conveyance system capacity standards** per Section 1.2.4.
- The applicable **area-specific water quality treatment menu** determined from the Water Quality Applications Map per Section 1.2.8.1, and any applicable special requirements for **source control** or **oil control** determined from Sections 1.3.4 and 1.3.5.

Flow Control System (Part D)

This section requires:

- An **illustrative sketch** of the flow control facility (or facilities), required flow control BMPs, and appurtenances. The facility sketch (or sketches) must show basic measurements necessary to calculate the storage volumes available from zero to the maximum head, all orifice/restrictor sizes and head relationships, control structure/restrictor orientation to the facility, and facility orientation on the *site*. The flow control BMP sketch (or sketches) must show basic measurements and dimensions, orientation on the *site*, flowpath lengths, etc.
- The applicant shall include all **supporting documentation** such as computer printouts, calculations, equations, references, storage/volume tables, graphs, soils data, geotechnical reports and any other aides necessary to clearly show results and methodology used to determine the storage facility volumes and flow control BMP applications.
- **Facility documentation** files, flow duration comparison files, peaks files, return frequency or duration curves, etc., developed with the approved model shall be included to verify the facility meets the performance standards indicated in Part C.
- The **volumetric safety factor** used in the design shall be clearly identified, as well as the

reasoning used by the design engineer in selecting the safety factor for this project.

- If **flow control BMP credits** are used as allowed in Core Requirement 9, documentation must be provided, explaining how the credits will be used and how the criteria for use of credits will be met.
- If the flow control system is an infiltration facility, the soils data, groundwater mounding analysis, and other calculations used to determine the **design infiltration rate** shall be provided.
- **Flow control BMP infeasibility** discussion and supporting documentation shall also be included in Part D.

Water Quality System (Part E)

This section provides an **illustrative sketch** of the proposed water quality facility (or facilities), source controls, oil controls, and appurtenances. This sketch (or sketches) of the facility, source controls, and oil controls must show basic measurements and dimensions, orientation on the site, location of inflow, bypass, and discharge systems, etc.

The applicant shall also include all **supporting documentation** such as computer printouts, calculations, equations, references, and graphs necessary to show the facility was designed and sized in accordance with the specifications and requirements in Chapter 6. If the **water quality credit option** is used as allowed in Section 6.1.3, documentation must be provided, identifying the actions that will be taken to acquire the requisite credits.

□ TIR SECTION 5 CONVEYANCE SYSTEM ANALYSIS AND DESIGN

This section shall present a detailed analysis of any existing conveyance systems, and the analysis and design of the proposed stormwater collection and conveyance system for the development. This section also includes any analysis required for the design of bridges to convey flows and pass sediments and debris per Section 4.4.3. Analysis information should be presented in a clear, concise manner that can be easily followed, checked, and verified. All pipes, culverts, catch basins, channels, swales, and other stormwater conveyance appurtenances must be clearly labeled and correspond directly to the engineering plans.

The **minimum information** included shall be pipe flow tables, flow profile computation tables, nomographs, charts, graphs, detail drawings, and other tabular or graphic aides used to design and confirm performance of the conveyance system.

Verification of capacity and performance must be provided for each element of the conveyance system. The analysis must show design velocities and flows for all drainage facilities within the development, as well as those offsite, which are affected by the development. If the final design results are on a computer printout, a separate summary tabulation of conveyance system performance shall also be provided.

□ TIR SECTION 6 SPECIAL REPORTS AND STUDIES

Some site characteristics, such as creeks, closed depressions, lakes, wetlands, or Hazard Areas, pose unique road and drainage design problems that are particularly sensitive to stormwater runoff. As a result, Kent may require the preparation of special reports and studies to address further the *site* characteristics, the potential for impacts associated with the development, and the measures that would be implemented to mitigate impacts. Special reports shall be prepared by people with expertise in the particular area of analysis. **Topics of special reports** may include any of the following:

- Geotechnical/soils (soils documentation supporting flow control BMP design, infiltration rate determination and infeasibility conclusions may also be located in TIR Section 6)
- Critical areas analysis and delineation Floodplain delineation in accordance with Section 1.3.2
- Flood protection facility conformance in accordance with Section 1.3.3

- Slope protection/stability
- Groundwater, including groundwater mounding analyses required for infiltration design
- Fluvial geomorphology
- Erosion and deposition
- Anadromous fisheries impacts
- Structural design
- Geology/Geologic Hazard Areas
- Hydrology
- Water quality
- Structural fill

❑ TIR SECTION 7 OTHER PERMITS

Construction of road and drainage facilities may require additional permits from other agencies for some projects. These additional permits may contain more restrictive drainage plan requirements. This section of the TIR should provide the titles of any other permits, the agencies requiring the other permits, and the permit requirements that affect the drainage plan. Examples of other permits are listed in Section 1.1.3.

❑ TIR SECTION 8 ESC ANALYSIS AND DESIGN

This section of the TIR should include the analysis and design information used to prepare the required **construction stormwater pollution prevention (CSWPP) plan**. This information should be presented in two parts associated with the CSWPP plan's two component plans, the erosion sediment control (ESC) plan (Part A) and the stormwater pollution prevention and spill control (SWPPS) plan (Part B). See Sections 2.3.1.3 and 2.3.1.4 for plan specifications and contents. This CSWPP plan is intended to be equivalent to and may be more stringent than that required for the NPDES Stormwater Construction Permit issued by Ecology.

ESC Plan Analysis and Design (Part A)

This section must include all hydrologic and hydraulic information used to analyze and design the erosion and sediment control measures, including final *site* stabilization measures. The TIR shall explain how proposed ESC measures comply with the *Erosion and Sediment Control Standards* in detached Appendix D and show compliance with the implementation requirements of Core Requirement #5, Section 1.2.5.

Part A must include the following:

1. **Provide sufficient information to justify the overall ESC plan** and the choice of individual erosion control measures. At a minimum, there shall be a discussion of each measure specified in Section 1.2.5 and its applicability to the proposed project.
2. Include all **hydrologic and hydraulic information** used to analyze and size the ESC facilities shown in the engineering plans. Describe the methodology, and attach any graphics or sketches used to size the facilities.
3. Identify areas with a particularly high susceptibility to erosion because of slopes or soils as well as areas to be protected for existing and proposed flow control BMPs. Discuss any **special measures** taken to protect these areas as well as any special measures proposed to protect water resources on or

near the *site*.

4. Identify any **ESC recommendations in any of the special reports** prepared for the project. In the project geotechnical report supporting flow control BMP design, provide recommendations to address mitigation of flow control BMP areas impacted by erosion and/or sedimentation during construction. If these special reports' recommendations are not included in the ESC plan, provide justification.
5. If proposing **exceptions or modifications to the standards detailed** in the *Erosion and Sediment Control Standards* (Appendix D of the King County Manual), clearly present the rationale. If proposing techniques or products different from those detailed in the *ESC Standards*, provide supporting documentation so the City can determine if the proposed alternatives provide similar protection.

SWPPS Plan Design (Part B)

The **stormwater pollution prevention and spill control plan** must identify all activities that could contribute pollutants to surface and storm water during construction. This section of the TIR must provide sufficient information to justify the selection of specific stormwater pollution prevention (SWPPS) BMPs proposed to be applied to the pollution-generating activities that will occur with construction of the proposed project. BMPs applicable to such activities are found in the *Construction Stormwater Pollution Prevention and Spill Control (CSWPP) Standards* (detached Appendix D) and the *King County Stormwater Pollution Prevention Manual* (viewable at <http://www.kingcounty.gov/environment/water-and-land/stormwater/documents/pollution-prevention-manual.aspx>).

At a minimum, there shall be a discussion of each anticipated pollution-generating activity and the pollution prevention BMPs selected to address it. If there are any **calculations** required for the selected BMP, include those in the discussion. If an **alternative BMP** or major modification to one of the City's standard BMPs will be used, a written request must be submitted for review and approval, detailing how the alternative will work. An "Alternative BMP Request Form" is available in the *Stormwater Pollution Prevention Manual*.

Updates or revisions to the SWPPS plan may be requested by the City of Kent at any time during project construction if the City determines that pollutants generated on the construction site have the potential to contaminate surface, storm, or ground water.

The SWPPS plan shall also **discuss the receiving waters**, especially if the receiving water body is listed on the **303d list**. Information must be provided that shows the plan meets **TMDL requirements**. Discuss the 303(d) listed pollutant generated or used onsite and any special handling requirements or BMPs.

□ TIR SECTION 9 BOND QUANTITIES, FACILITY SUMMARIES, AND DECLARATION OF COVENANT

Bond Quantities Worksheet

Each plan submittal requires a construction quantity summary to establish appropriate bond amounts. Using the *Bond Quantities Worksheet* (Contact the City of Kent Economic and Community Development Department), the design engineer shall separate existing right-of-way and erosion control quantities from other onsite improvements. In addition, the engineer shall total the amounts based on the unit prices listed on the form.

Drainage facilities for single-family residential building permits shall be constructed and approved prior to granting the certificate of occupancy.

Flow Control and Water Quality Facility Summary Sheet and Sketch

Following approval of the plans, a *Flow Control and Water Quality Facility Summary Sheet and Sketch* (see

Reference 8-C) shall be submitted along with an 8^{1/2}" x 11" plan sketch for each facility proposed for construction. The plan shall show a north arrow, the tract, the facility access road, the extent of the facility, and the control structure location. The approximate street address shall be noted. At project completion, the Summary Sheet and Sketch shall be updated in the Final Corrected TIR to reflect the completed project (see Section 2.4.2).

Declaration of Covenant for Privately Maintained Flow Control and WQ Facilities

Any declaration of covenant and grant of easement required for proposed flow control and water quality facilities per Section 1.2.6 must be included here for **review and approval before recording**. The necessary covenant exhibits, and maintenance instructions associated with the facility type shall be included with the declaration of covenant. **After approval by city review staff**, the declaration of covenant and grant of easement must be signed and recorded with the City of Kent before any permit is approved. A copy of the recorded document shall be included in the Final Corrected TIR (see Section 2.4.2).

Declaration of Covenant for Privately Maintained Flow Control BMPs

Any declarations of covenant and grant of easement required for proposed flow control BMPs per Core Requirement 9 must be included here for **review and approval before recording**. The necessary covenant exhibits, and maintenance instructions associated with the flow control BMP type (see Reference 5), shall be included with the declaration of covenant. **After approval by city review staff**, all such documents must be signed and recorded with the City of Kent before any permit is approved. A copy of the recorded document shall be included in the Final Corrected TIR (see Section 2.4.2) or otherwise provided to the County if no TIR was required.

❑ TIR SECTION 10 OPERATIONS AND MAINTENANCE MANUAL

For each flow control and water quality facility and/or BMP that is to be privately maintained, and for those that have special nonstandard features, the design engineer shall prepare an operations and maintenance manual. The manual should be simply written and should contain a brief description of the facility or BMP, what it does, and how it works. In addition, the manual shall include a copy of the *Stormwater Facility Maintenance Guide* (see Appendix A) and provide an outline of maintenance tasks and the recommended frequency each task should be performed. This is especially important for flow control BMPs and water quality facilities where proper maintenance is critical to facility performance. For this reason, most of the flow control facility designs in Chapter 5 and the water quality facility designs in Chapter 6 include “maintenance considerations” important to the performance of each facility.

2.3.1.2 SITE IMPROVEMENT PLAN

Site improvement plans shall portray design concepts in a clear and concise manner. The plans must present all the information necessary for persons trained in engineering to review the plans, as well as those persons skilled in construction work to build the project according to the design engineer's intent. Supporting documentation for the site improvement plans must also be presented in an orderly and concise format that can be systematically reviewed and understood by others.

The **vertical datum** on which all engineering plans, plats, binding site plans, and short plats are to be based must be North American Vertical Datum of 1988, (NAVD88) and the datum must be tied to at least one City of Kent Survey Control Network benchmark. The benchmark(s) shall be shown or referenced on the plans. Datum correlations can be found in Table 4.4.2.B of the King County Manual.

Horizontal control for all plats, binding site plans, and short plats shall reference the North American Datum of 1983/1991 adjustment (NAD83/91) as the coordinate base and basis of bearings. All horizontal

control for these projects must be in U.S. Survey Foot and referenced to a minimum of two City of Kent Survey Horizontal Control monuments. If two horizontal control monuments do not exist within one mile of the project, an assumed or alternate coordinate base and basis of bearings may be used. Horizontal control monument and benchmark information is available from the Kent Public Works Department.

The site improvement plans consist of all the plans, profiles, details, notes, and specifications necessary to construct road, drainage structure, and off-street parking improvements. Site improvement plans include the following:

- **A base map** (described in Table 2.3.1.A), and
- **Site plan and profiles** (see Section 2.3.1.1).

Note: Site improvement plans must also include grading plans if onsite grading extends beyond the roadway.

Modified Site Improvement Plan

City review staff may allow a modified site improvement plan for some projects in Targeted Drainage Review (see Section 2.3.2) or where major improvements (e.g., detention facilities, conveyance systems, bridges, road right-of-way improvements, etc.) are not proposed. The modified site improvement plan must:

1. Be drawn on a 11" x 17" or larger sheet,
2. Accurately locate structure(s) and access, showing observance of the setback requirements given in this manual, or other applicable documents, and
3. Provide enough information (datum, topography, details, notes, etc.) to address issues as determined by city review staff.

□ GENERAL PLAN FORMAT

Site improvement plans should use *APWA Standard Map Symbols* as appropriate, and must include *Standard Plan Notes* (see Appendix A of the Kent Construction Standards). Each plan must follow the general format detailed below:

1. Plan sheets and profile sheets, or combined **plan and profile sheets**, specifications, and detail sheets as required shall be on 22 inch by 34 inch sheets. Right-of-way improvements must be on 22 inch by 34 inch. Original sheets shall be in PDF or DWG file format.
2. Drafting details shall generally conform to *APWA Standard Map Symbols* with lettering size (before reduction) no smaller than Leroy 80 (Leroy 100 is preferred). Existing features shall be shown with dashed lines or as half-toned (screened) to clearly distinguish existing features from proposed improvements.
3. Each submittal shall contain a project information/cover sheet with the following:
 - a) Title: Project name and Kent Permit number
 - b) Table of contents (if more than three pages)
 - c) Vicinity map
 - d) Name and phone number of utility field contacts (e.g., water, sanitary sewer, gas, power, telephone, and TV) and the One-Call number (1-800-424-5555)
 - e) Kent's preconstruction/inspection notification requirements
 - f) Name and phone number of the erosion control supervisor
 - g) Name and phone number of the surveyor
 - h) Name and phone number of the owner/agent
 - i) Name and phone number of the applicant

-
- j) Legal description
 - k) Plan approval signature block for the Development Review Engineer
 - l) Name and phone number of the engineering firm preparing the plans (company logos acceptable)
 - m) Fire Marshal's approval stamp (if required)
 - n) Statement that mailbox locations have been designated or approved by the U.S. Postal Service (where required)
 - o) List of conditions of preliminary approval and conditions of approved adjustments and variances on all *site* improvements.
4. An **overall site plan** shall be included if more than three plan sheets are used. The overall plan shall be indexed to the detail plan sheets and include the following:
 - a) The complete property area development
 - b) Right-of-way information
 - c) Street names and road classification
 - d) All project phasing and proposed division boundaries
 - e) All natural and proposed drainage collection and conveyance systems with catch basin numbers shown
 5. Each sheet of the plan set shall be stamped, signed, and dated by a **licensed civil engineer** registered in the State of Washington. At least one sheet showing all boundary survey information must be provided and stamped by a **professional land surveyor** licensed in the State of Washington.
 6. **Detail sheets** shall provide sufficient information to construct complex elements of the plan. Details may be provided on plan and profile sheets if space allows.
 7. A **title block** shall be provided on each plan sheet. At a minimum, the title block shall list the following:
 - a) Development title
 - b) Name, address, and phone number of the firm or individual preparing the plan
 - c) A revision block
 - d) Page (of pages) numbering
 - e) Sheet title (e.g., road and drainage, grading, erosion and sediment control, stormwater pollution prevention and spill control)
 8. The **location and label** for each section or other detail shall be provided.
 9. **Critical areas**, critical area buffers, and critical area building setbacks as required by Kent City Code shall be delineated and labeled.
 10. All **match lines** with matched sheet number shall be provided.
 11. All division or phase lines and the **proposed limits of construction** under the permit application shall be indicated.
 12. Reference all identified wetlands (sequentially if more than one).
 13. The standard plan notes that apply to the project shall be provided on the plans (see Appendix A of the Kent Construction Standards).
 14. Commercial building permit applications shall include the **designated zoning** for all properties adjacent to the development *site(s)*.
-

□ BASE MAP

A site improvement plan **base map** provides a common base and reference in the development and design of any project. A base map helps ensure that the engineering plans, grading plans, and CSWPP plans are all developed from the same background information. This base map shall include the information listed in Table 2.3.1.A.

TABLE 2.3.1.A BASE MAP REQUIREMENTS	
Feature	Requirements
Ground Surface Topography	Provide topography within the <i>site</i> and extending beyond the property lines. Contour lines must be shown as described in “Plan View: Site Plan and Roadway Elements” (see Section 2.3.1.2).
Surface Water Discharge	Provide ground surface elevations for a reasonable “fan” around points of discharge extending at least 50 feet downstream of all point discharge outlets.
Hydrologic Features	Provide spot elevations in addition to contour lines to aid in delineating the boundaries and depth of all existing floodplains, wetlands, channels, swales, streams, storm drainage systems and BMPs, roads (low spots), closed depressions, springs, seeps, swales, ditches, pipes, groundwater, and seasonal standing water.
Other Natural Features	Show the location and relative sizes of other natural features such as rock outcroppings, existing vegetation, and trees 12 inches in diameter and greater that could be disturbed by the project improvements and construction activities (within tree canopy), noting species.
Flows	Provide arrows that indicate the direction of surface flow on all public and private property and for all existing conveyance systems.
Floodplains/ Floodways	Show the floodplain/floodways as depicted on City of Kent maps or otherwise required by the City of Kent.
General Background Information	Show the location and limits of all existing: <ul style="list-style-type: none"> • Property boundaries • Structures • Easements (including dimensions) • Total property (including dimensions) • Roads and right-of-way • Sanitary sewers and water utilities • Common open space • Public dedications • Other manmade features affecting existing topography/proposed improvements.
Development Limitations	Delineate limitations to the development that may occur as identified on the TIR worksheet, Part 11 (see Reference 8-A).

□ SITE PLAN AND PROFILES

The design engineer shall provide plans and profiles for all construction, including but not limited to the following information.

Plan View: Site Plan and Roadway Elements

1. Provide **property lines, right-of-way lines**, and widths for proposed roads and intersecting roads.
Note: the condition of all public right-of-way and the right to use it as proposed must be verified.
2. Provide all existing and proposed **roadway features**, such as centerlines, edges of pavement and shoulders, ditchlines, curbs, and sidewalks. In addition, show points of access to abutting properties

and roadway continuations.

3. Show existing and proposed **topography contours** at 2-foot intervals (5-foot intervals for slopes greater than 15 percent, 10-foot intervals for slopes greater than 40 percent). Contours may be extrapolated from USGS mapping, aerial photographs, or other topography map resources. However, contours shall be field verified for roadway and stream centerlines, steep slopes, floodplains, drainage tracts easements, and conveyance systems. Contours shall extend 50 feet beyond property lines to resolve questions of setback, cut and fill slopes, drainage swales, ditches, and access or drainage to adjacent property.
4. Show the location of all existing **utilities** and proposed utilities (except those designed by the utility and not currently available) to the extent that these will be affected by the proposed project. Clearly identify all existing **utility poles**.
5. Identify all roads and adjoining subdivisions.
6. Show **right-of-way** for all proposed roadways, using sufficient dimensioning to clearly show exact locations on all sections of existing and proposed dedicated public roadway.
7. Clearly differentiate areas of **existing pavement** and areas of **new pavement**. If the project is a **redevelopment project**, delineate areas of **replaced impervious surface**.
8. For subdivision projects, use **drawing scales** of 1"=50'. For commercial, multi-family, or other projects, use scales of 1"=20'. Show details for clarification, including those for intersections and existing driveways, on a larger scale.
9. Identify all section, township and range information for the project area.

Plan View: Drainage Conveyance

1. Sequentially **number all catch basins and curb inlets** starting with the structure farthest downstream.
2. Represent **existing storm drainage facilities and BMPs** in dashed lines and label with "Existing."
3. Clearly label existing storm drainage **facilities to be removed** with "Existing to be removed."
4. Show the length, diameter, and material for all **pipes, culverts, and stub-outs**. Include the slope if not provided on the profile view. Material may be noted in the plan notes. Where open conveyance is provided, and a low-permeability liner or treatment liner is required per Section 6.2.4, indicate the limits of such liner(s).
5. Clearly label **catch basins** as to size and type (or indicate in the plan notes).
6. Clearly label **downspout and footing drain stub-out locations** for those lots intending to connect to the storm drainage flow control system. Locate all stub-outs to allow gravity flow from the lowest corner of the lot to the connecting catch basin.
7. Show **datum, benchmark locations, and elevations** on each plan sheet.
8. Clearly label all stub-out locations for any **future pipe connections**.
9. Clearly show on the plans all drainage **easements, tracts**, access easements, Native Growth Retention Areas, Critical Area Tracts, Critical Area Setback Areas, and building setback lines. Show dimensions, type of restriction, and use.
10. Using arrows indicate **drainage direction** of hydraulic conveyance systems.

Plan View: Other

1. Show the location, identification, and dimensions of all buildings, property lines, streets, alleys, and easements.
2. Verify the condition of all public right-of-way and the rights to use them as proposed.
3. Show the locations of structures on abutting properties within 50 feet of the proposed project site.

4. Show the location of all proposed drainage facility fencing, together with a typical section view of each fencing type.
5. Provide section details of all retaining walls and rockeries, including sections through critical portions of the rockeries or retaining walls.
6. Show all existing and proposed buildings with projections and overhangs.
7. Show the location of all wells on site and within 100 feet of the site. Note wells to be abandoned.
8. Show structural BMPs required by the *King County Stormwater Pollution Control Manual* and any subsequent revisions.

Profiles: Roadway and Drainage

1. Provide **existing centerline ground profile** at 50-foot stations and at significant ground breaks and topographic features, with average accuracy to within 0.1 feet on unpaved surface and 0.02 feet on paved surface.
2. For publicly maintained roadways, provide **final road and storm drain profile** with the same stationing as the horizontal plan, reading from left to right, to show stationing of points of curve, tangent, and intersection of vertical curves, with elevation of 0.01 feet. Include tie-in with intersecting pipe runs.
3. On a grid of numbered lines, provide a continuous plot of **vertical positioning against horizontal**.
4. Show finished **road grade and vertical curve data** (road data measured at centerline or edge of pavement). Include stopping sight distance.
5. Show all **roadway drainage**, including drainage facilities and BMPs, that are within the right-of-way or easement.
6. On the profile, show slope, length, size, and type (in plan notes or on a detail sheet) for all **pipes and detention tanks** in public right-of-way.
7. Indicate the inverts of all pipes and culverts and the elevations of catch basin grates or lids. It is also desirable, but not required, to show invert elevations and grate elevations on plan sheets.
8. For pipes that are proposed to be within 2.0 feet of finished grade, indicate the **minimum cover dimensions**.
9. Indicate **roadway stationing** and offset for all catch basins.
10. Indicate **vertical and horizontal scale**.
11. Clearly label all profiles with respective street names and plan sheet reference numbers, and indicate all profile sheet reference numbers on plan sheets, if drawn on separate sheets.
12. Locate **match points with existing pavements**, and show elevations.
13. Show all **property boundaries**.
14. Label all **match line locations**.
15. Provide profiles for all **12-inch and larger pipes** and for **channels** (that are not roadside ditches).
16. Show the location of all existing and proposed (if available or critical for clearance) **gas, water, and sanitary sewer crossings**.
17. Show **energy dissipater locations**.
18. Identify **datum** used and all **benchmarks** (may be shown on plan view instead). Datum and benchmarks must refer to established control when available.
19. Use a **vertical scale** of 1"=5'. As an exception, vertical scale shall be 1"=10' if the optional 1"=100' horizontal scale is used on projects with lots one acre or larger. Clarifying details, including those for intersections and existing driveways, should use a larger scale.
20. **Split sheets**, with the profile aligned underneath the plan view, are preferred but not required.

□ DETAILS

The design engineer shall provide details for all construction, including but not limited to the following.

Flow Control, Water Quality, and Infiltration Facility Details

1. Provide a scaled drawing and supporting details of each detention pond or vault, flow control BMP and water quality facility, including the tract boundaries.
2. Show predeveloped and finished grade **contours** at 2-foot intervals. Show and label **maximum design water elevation**.
3. Dimension all **berm widths**.
4. Show and label at least two **cross sections** through a pond or water quality facility, or any BMP large enough to require design elements of ponds and/or water quality facilities. One cross section must include the restrictor when included in the design.
5. Specify **soils and compaction requirements** for pond construction and flow control BMP construction. Specify low-permeability liners or treatment liners as required for ponds and ditches per Section 6.2.4.
6. Show the location and detail of **emergency overflows, spillways, and bypasses**.
7. Specify **rock protection/energy dissipation** requirements and details.
8. Provide **inverts** of all pipes, grates, inlets, tanks, and vaults, and **spot elevations** of the pond bottom.
9. Show the location of **access roads** to control manholes and pond/forebay bottoms.
10. Provide plan and section views of all **energy dissipaters**, including **rock splash pads**. Specify the size of rock and thickness.
11. Show **bollard locations** on plans. Typically, bollards are located at the entrance to drainage facility access roads.
12. On the pond or water quality facility detail, show the size, type (or in plan notes), slope, and length of all **pipes**.
13. Show to scale the section and plan view of **restrictor and control structures**. The plan view must show the location and orientation of all inlet pipes, outlet pipes, and flow restrictors.
14. Draw details at one of the following scales: 1"=1', 1"=2', 1"=4', 1"=5', 1"=10', or 1"=20'. Select a scale that clearly shows required information.

Structural Plan Details

Any submittal that proposes a structure (e.g., bridge crossing, reinforced concrete footings, walls, or vaults) shall include plan sheets that include complete working drawings showing dimensions, steel placement, and specifications for construction. Structures may require a design prepared and stamped by a professional structural engineer licensed in the State of Washington, and an application for a separate commercial building permit.

2.3.1.3 EROSION AND SEDIMENT CONTROL (ESC) PLAN

This section details the specifications and contents for ESC plans. Note that an ESC plan includes the plan's drawings plus an ESC report, which provides all supporting information and any additional direction necessary for implementing ESC measures and meeting ESC implementation requirements. The ESC plan may be simplified by the use of the symbols and codes provided for each ESC measure in the *Erosion and Sediment Control Standards* (detached Appendix D of the King County Manual). In general, the ESC plan shall be submitted as a separate plan sheet(s). However, there may be some relatively simple projects where providing separate grading and ESC plans is unnecessary.

General Specifications

The **site improvement plan** shall be used as the base of the ESC plan. Certain detailed information that is not relevant (e.g., pipe/catch basin size, stub-out locations, etc.) may be omitted to make the ESC plan easier to read. At a minimum, the ESC plan shall include all of the information required for the base map (see Table 2.3.1.A), as well as existing and proposed roads, driveways, parking areas, buildings, drainage facilities and BMPs, utility corridors not associated with roadways, *relevant critical areas*³³ and critical area *relevant critical areas*³ and critical area buffers, and proposed final topography. A smaller scale may be used to provide better comprehension and understanding.

The ESC plan shall generally be designed for proposed topography, not existing topography, since rough grading is usually the first step in *site* disturbance. The ESC plan shall **address all phases of construction** (e.g., clearing, grading, and installation of utilities, surfacing, and final stabilization). If construction is being phased, separate ESC plans may need to be prepared to address the specific needs for each construction phase.

The **ESC plan** shall be consistent with the information provided in Section 8 of the TIR and shall show the following:

1. Identify areas with a high susceptibility to erosion.
2. Provide all details necessary to clearly illustrate the intent of the ESC design.
3. Include ESC measures for all on- and offsite utility construction included in the project.
4. Specify the construction sequence. The construction sequence shall be specifically written for the proposed project. An example construction sequence is provided in Appendix D of the King County Manual.
5. Include *ESC Standard Plan Notes*.
6. Include an inspection and maintenance program for ESC measures, including designation of a CSWPP supervisor who is a certified ESC professional and identification of phone numbers for 24-hour contact.
7. Include the basis and calculations for selection and sizing of ESC measures.

³³ *Relevant critical areas*, for the purposes of drainage review, include aquatic areas, wetlands, *flood hazard areas*, *erosion hazard areas*, *landslide hazard areas*, *steep slope hazard areas*, and *critical aquifer recharge areas*.

Clearing Limits

1. **Delineate** clearing limits.
2. Provide **details** sufficient to install and maintain the clearing limits.

Cover Measures

1. Specify the type and location of **temporary cover measures** to be used onsite.
2. If **more than one type** of cover is to be used onsite, indicate the areas where the different measures will be used, including steep cut and fill slopes.
3. If the type of cover measures to be used will vary depending on the time of year, soil type, gradient, or some other factor, specify the **conditions that control the use of the different measures**.
4. Specify the nature and location of **permanent cover measures**. If a landscaping plan is prepared, this may not be necessary.
5. Specify the approximate amount of cover measures necessary to cover all disturbed areas.
6. If **netting or blankets, or plastic sheeting** are specified, provide typical detail sufficient for installation and maintenance.
7. Specify the **mulch types, seed mixes, fertilizers, and soil amendments** to be used, as well as the application rate for each item.
8. For **surface roughening**, describe methods, equipment and areas where surface roughening will be use.
9. If **PAM** is used, show location(s) and describe application method.
10. When **compost blankets** are used, show location, application rates, and the name of the supplier to document that compost meets quality specifications per Reference 11-C.

Perimeter Protection

1. Specify the **location and type** of perimeter protection to be used.
2. Provide **typical details** sufficient to install and maintain the perimeter protection.
3. If **silt fence** is to be used, specify the type of fabric to be used.
4. If **compost berms or socks** are used, documentation must be provided to assure the supplier meets the criteria and compost meets quality standards per Reference 11-C.

Traffic Area Stabilization

1. Locate the construction entrance(s).
2. Provide typical details sufficient to install and maintain the construction entrance.
3. Locate the construction roads and parking areas.
4. Specify the measure(s) that will be used to create stabilized construction roads and parking areas. Provide sufficient detail to install and maintain.
5. If a wheel wash or tire bath system will be installed, provide location, typical details for installation and maintenance.
6. Provide a list of dust control products that will be used onsite and the location of potential application areas.

Sediment Retention

1. Show the **locations** of all sediment ponds and traps.
 2. Dimension pond **berm widths** and all inside and outside pond slopes.
 3. Indicate the **trap/pond storage** required and the depth, length, and width dimensions.
 4. Provide typical **section views** through pond and outlet structures.
-

5. If **chemical or electrocoagulation treatment** of sediment-laden waters will be used, approval documentation from Ecology must be included (see SWPPS plan requirements for chemical storage).
6. Provide details for disposal of contaminated or chemically treated waters (e.g., where Chitosan or CO₂ have been used) (see SWPPS plan requirements for chemical storage).
7. Include appropriate **approval documentation from local sewer districts** if contaminated or chemically treated water will be discharged to the sanitary sewer.
8. Provide typical details of the **control structure** and **dewatering mechanism**.
9. Detail **stabilization techniques** for outlet/inlet protection.
10. Provide details sufficient to install **cell dividers**.
11. Specify mulch or recommended **cover of berms and slopes**.
12. Indicate the **required depth gage** with a prominent mark at 1-foot depth for sediment removal.
13. Indicate **catch basins** that are to be protected.
14. Indicate existing and proposed flow control BMP areas that are to be protected.
15. Provide **details of the catch basin and flow control BMP protection** sufficient to install and maintain.

Surface Water Control

1. **Locate** all pipes, ditches, interceptor ditches, and swales that will be used to convey stormwater.
2. Provide **details** sufficient to install and maintain all **conveyances**.
3. Indicate locations of **outlet protection**, and provide detail of protections.
4. Indicate locations and outlets of any possible **dewatering systems**. Provide details of alternative discharge methods from dewatering systems if adequate infiltration rates cannot be achieved. Do not route dewatering water, clean or untreated, through stormwater sediment ponds.
5. Indicate the location of any **level spreaders**, and provide details sufficient to install and maintain.
6. Show all **temporary pipe inverts**.
7. Provide location and specifications for the **interception of runoff from disturbed areas** and the conveyance of the runoff to a non-erosive discharge point.
8. Provide **locations** and details of **rock check dams**.
9. Provide **details**, including front and side sections of typical **rock check dams**.

Protection of Existing and Proposed Flow Control BMP Areas

1. Provide perimeter protection at existing and proposed flow control BMP locations.
2. Provide cautionary plan notes emphasizing avoidance of negative impacts to receptor soils and existing vegetation to remain.

BMP Maintenance

1. Provide adequate plan notes for guidance of BMP maintenance methods and schedules.
2. Include an inspection and maintenance program for ESC measures.

Management of the Project

1. Provide plan notes to clarify and emphasize the management responsibilities for the project.
2. Include an inspection and maintenance program for ESC measures, including designation of a CSWPP supervisor who is a certified ESC professional and identification of phone numbers for 24-hour contact.

Wet Season Requirements

1. Provide a **list** of all applicable wet season requirements.
2. Clearly identify that from October 1st through April 30th, no soils shall be exposed for more than two consecutive working days. Also note that this **two-day requirement** may be applied at other times of the year if storm events warrant more conservative measures.
3. Clearly identify that **exposed soils shall be stabilized** at the end of the workday prior to a weekend, holiday, or predicted rain event.

Critical Areas Restrictions

1. **Delineate and label** the following critical areas, and any applicable buffers, that are on or adjacent to the *project site*: aquatic areas, wetlands, *flood hazard areas*, *erosion hazard areas*, *landslide hazard areas*, *steep slope hazard areas*, and *critical aquifer recharge areas*.
2. If construction creates disturbed areas within any of the above listed critical areas or associated buffers, specify the type, locations, and details of any measures or other provisions necessary to **comply with the critical area restrictions** in Appendix D and protect surface waters and steep slopes.

2.3.1.4 STORMWATER POLLUTION PREVENTION AND SPILL (SWPPS) PLAN

This section details the specifications and contents for SWPPS plans, which together with ESC plans, comprise the construction stormwater pollution prevention (CSWPP) plan that must be submitted as part of the engineering plans required for drainage review. Additional guidance for developing the SWPPS plan can be found in the *SWPPS Standards* in the KCSWDM Appendix D, *Construction Stormwater Pollution Prevention Standards*, in the King County *Stormwater Pollution Prevention Manual* and in the *Stormwater Management Manual for Western Washington (SWMMWW)* published by the Washington State Department of Ecology (Ecology).

The SWPPS plan must be kept on *site* during all phases of construction and shall **address the construction-related pollution-generating activities outlined in Subsection A below**. The plan must include a description of the methods the general contractor will use to ensure sub-contractors are aware of the SWPPS plan. A **form or record** must be provided that states all sub-contractors have read and agree to the SWPPS plan.

A SWPPS plan consists of the following three elements, which are further described in Subsections B, C, and D below:

1. A **site plan** showing the location and description of BMPs required to prevent pollution and control spills from construction activities and from chemicals and other materials used and stored on the construction site. See Subsection B below for more specifics on the SWPPS site plan.
2. A **pollution prevention report** listing the potential sources of pollution and identifying the operational, source control, and treatment BMPs necessary to prevent/mitigate pollution from these sources. See Subsection C below for more specifics on the SWPPS pollution prevention report.
3. A **spill prevention and cleanup report** describing the procedures and BMPs for spill prevention and including provisions for cleanup of spills should they occur. See Subsection D below for more specifics on the SWPPS spill prevention and cleanup report.

A. ACTIVITY-SPECIFIC INFORMATION REQUIRED

At a minimum, the SWPPS plan shall address, if applicable, the following pollution-generating activities typically associated with construction and include the information specified below for each activity. If other pollution-generating activities associated with construction of the proposed project are identified, the SWPPS plan must address those activities in a similar manner.

Storage and Handling of Liquids

1. Identify liquids that will be handled or stored onsite, including but not limited to **petroleum products, fuel, solvents, detergents, paint, pesticides, concrete admixtures, and form oils**.
2. Specify **types and sizes of containers** of liquids that will be stored/handled onsite. Show locations on the SWPPS site plan.
3. Describe **secondary containment methods** adequately sized to provide containment for all liquids stored onsite. Show the locations of containment areas on the SWPPS site plan.

Storage and Stockpiling of Construction Materials and Wastes

1. **Identify** construction materials and wastes that may be generated or stockpiled onsite. Show the **locations** where these materials and wastes will be generated and stockpiled on the SWPPS site plan.
2. Specify type of **cover measures** to be used to keep rainwater from contacting construction materials and wastes that can contribute pollutants to storm, surface, and ground water.
3. If wastes are kept in **containers**, describe how rainwater will be kept out of the containers.

Fueling

1. Specify **method of onsite fueling** for construction equipment (i.e. stationary tanks, truck mounted tanks, wet hosing, etc.). If stationary tanks will be used, show their location on the SWPPS site plan.
2. Describe **type and size of tanks**.
3. Describe **containment methods for fuel spills** and make reference to the SWPPS site plan for location information.
4. If fueling occurs **during evening hours**, describe lighting and signage plan. Make reference to the SWPPS site plan for location information.

Maintenance, Repairs, and Storage of Vehicles and Equipment

1. Identify **maintenance and repair areas** and show their locations on the SWPPS site plan. Use of drip pans or plastic beneath vehicles is required. A note to this effect must be shown on the SWPPS site plan.
2. Describe method for collection, storage, and disposal of **vehicle fluids**.
3. If an area is designated for vehicle maintenance, **signs must be posted** that state no vehicle washing may occur in the area. A note to this effect must be shown on the SWPPS site plan.

Concrete Saw Cutting, Slurry, and Washwater Disposal

1. Assure that washout of concrete trucks is performed off-site or in designated concrete washout areas only. Identify **truck washout areas** to assure such areas are not within a **critical aquifer recharge area**. If they are, the washout area must be lined with an impervious membrane. Show location information on the SWPPS site plan. Locate washout area at least 50 feet from sensitive areas such as storm drains, open ditches, or water bodies, including wetlands.
2. Specify **size of sumps** needed to collect and contain slurry and washwater. Show location information on the SWPPS site plan.

3. Identify **areas for rinsing hand tools** including but not limited to screeds, shovels, rakes, floats and trowels. Show the locations of these areas on the SWPPS site plan.
4. Describe **methods for collecting, treating, and disposal** of waste water from exposed aggregate processes, concrete grinding and saw cutting, and new concrete washing and curing water.

Handling of pH Elevated Water

New concrete vaults/structures may cause collected water to have an elevated pH. This water cannot be discharged to storm or surface water until neutralized.

1. Provide details on **treating/neutralizing water** when pH is not within neutral parameters. Written approval from Ecology is required before using chemical treatment other than CO₂ or dry ice to adjust pH.
2. Provide details on **disposal of water** with elevated pH or of the treated water.

Application of Chemicals including Pesticides and Fertilizers

1. Provide a **list of chemicals** that may be used on the *project site* and the application rates.
2. Describe **where and how chemicals will be applied**. Show location information on the SWPPS site plan.
3. Describe **where and how chemicals will be stored**. Show location information on the SWPPS site plan.

B. SWPPS SITE PLAN

The *site* plan element of the SWPPS plan shall include all of the information required for the base map (see Table 2.3.1.A, p. 2-23), as well as existing and proposed roads, driveways, parking areas, buildings, drainage facilities, utility corridors not associated with roadways, *relevant critical areas*³⁴ and associated buffers, and proposed final topography. A smaller scale may be used to provide more comprehensive details on specific locations of each activity and specific prevention measure. In addition to this information, the following items, at a minimum, shall be provided as applicable:

1. Identify locations where **liquids will be stored** and delineate secondary containment areas that will be provided.
2. Identify locations where **construction materials and wastes** will be generated and stockpiled.
3. Identify location of **fueling for vehicles and equipment** if stationary tanks will be used.
4. Delineate **containment areas** for fuel spills.
5. Show location of **lighting and signage** for fueling during evening hours.
6. Delineate **maintenance and repair areas** and clearly note that drip pans or plastic shall be used beneath vehicles. Also, clearly note that signs must be posted that state no **vehicle washing** may occur in the area.
7. Delineate **truck washout areas** and identify the location of **slurry/washwater sumps and**

³⁴ *Relevant critical areas*, for the purposes of drainage review, include aquatic areas, wetlands, *flood hazard areas*, *erosion hazard areas*, *landslide hazard areas*, *steep slope hazard areas*, and *critical aquifer recharge areas*.

rinsing areas for tools.

8. Delineate where **chemicals** will be applied and identify where they will be stored.
9. Identify where **spill response materials** will be stored.

C. POLLUTION PREVENTION REPORT

This report provides the specifics on pollution prevention and must include the following information in addition to the activity-specific information specified in Subsection A above:

1. List the possible **sources of pollution** per Subsection A above and identify the BMPs to be used for each source to prevent pollution. Include any **supporting information** (site conditions, calculations, etc.) for the selection and sizing of pollution prevention BMPs.
2. Identify the **personnel** responsible for pollution prevention and clearly list the responsibilities of each person identified. **Contact information** for these personnel must be clearly identified in the report and on the SWPPS site plan.
3. Describe the **procedures** to be used for monitoring pollution prevention BMPs and for responding to a BMP that needs attention, including keeping records/reports of all inspections of pollution prevent BMPs (see Reference Section 8-E for examples of worksheets that may be used).

D. SPILL PREVENTION AND CLEANUP REPORT

This report provides the specifics on spill prevention and cleanup and must include the following information in addition to any activity-specific information in Subsection A above related to spill prevention:

1. List the possible **sources of a spill** and identify the BMPs to be used for each source to prevent a spill.
2. Identify **personnel** responsible for spill prevention and cleanup and clearly list the responsibilities of each person identified. **Contact information** for these personnel must be clearly identified in the report and on the SWPPS site plan. (On typical projects, the primary contact for SWPPS issues will be the CSWPP supervisor, who may be managing other spill responders to assure compliance; complex projects may warrant specialist personnel for specific site applications.)
3. Describe the **procedures** to be used for monitoring spill prevention BMPs and for responding to a spill incident, including keeping records/reports of all inspections and spills (see Reference Section 8-E for examples of worksheets that may be used).
4. Identify where **spill response materials** will be stored. Make reference to the SWPPS site plan for location information.
5. Identify **disposal methods** for contaminated water and soil after a spill.

2.3.1.5 LANDSCAPE MANAGEMENT PLANS (IF APPLICABLE)

A *landscape management plan* is a Kent approved plan for defining the layout and long-term maintenance of landscaping features to minimize the use of pesticides and fertilizers, and reduce the discharge of suspended solids and other pollutants. General guidance for preparing landscape management plans is provided in Reference Section 4-C.

If a landscape management plan is proposed, it must be submitted with the engineering plans for the proposed project. The elements listed below are required for evaluation of landscape management plans.

1. Provide a **site vicinity map** with topography.

2. Provide a **site plan** with topography. Indicate areas with saturated soils or high water tables.
3. Provide a **plant list** (provide both common and scientific names) that includes the following information:
 - a) Indicate any drought-tolerant plants, disease resistant varieties, species for attracting beneficial insects (if any) and native plants.
 - b) For shrubs and groundcovers, indicate the proposed spacing.
 - c) For turf areas, indicate the grass mix or mixes planned. Indicate sun/shade tolerance, disease susceptibility, drought tolerance, and tolerance of wet soil conditions.
4. Provide a **landscape plan**. Indicate placement of landscape features, lawn areas, trees, and planting groups (forbs, herbs, groundcovers, etc.) on the *site*.
5. Include information on **soil preparation** and fertility requirements.
6. Provide information on the design of the **irrigation method** (installed sprinkler system, drip irrigation system, manual, etc.)
7. Provide a **landscape maintenance plan**, including the following:
 - a) Physical care methods, such as thatch removal or aeration, and mowing height and frequency.
 - b) Type of fertilizer (including N-P-K strength) and fertilization schedule or criteria.
 - c) Type of chemicals to be used for common pests such as crane fly larvae, and the criteria or schedule for application.
 - d) Any biocontrol methods.
8. Provide information about the **storage of pesticides or other chemicals**, and **disposal measures** that will be used:
 - a) If applicable, indicate how the chemicals will be stored on the *site* between applications to prevent contact with stormwater or spills into the storm drainage system.
 - b) Indicate how excess quantities of fertilizers or chemicals will be handled for individual applications.
9. Provide an **implementation plan** (see Reference Section 4-C for guidance on preparing the implementation plan).

2.3.2 PROJECTS IN TARGETED DRAINAGE REVIEW

This section outlines the specifications and contents of limited scope engineering plans allowed for projects in Targeted Drainage Review. **Table 2.3.2.A** specifies the minimum required elements of the targeted technical information report based on the type of permit or project, and on the three categories of project characteristics subject to Targeted Drainage Review per Section 1.1.2.2.

**TABLE 2.3.2.A MINIMUM ENGINEERING PLAN ELEMENTS⁽¹⁾
FOR PROJECTS IN TARGETED DRAINAGE REVIEW**

Type of Permit or Project	Drainage Review Type	Project Category 1 ⁽²⁾	Project Category 2 ⁽²⁾	Project Category 3 ⁽²⁾
		Projects that contain or are adjacent to floodplains, streams, lakes, wetlands or closed depressions OR projects within a Landslide Hazard Area, Landslide Hazard Drainage Area or Erosion Hazard Area. Projects in TDR that contain or are adjacent to a <i>flood, erosion</i> , or <i>II. steep slope hazard area</i> ; or are within a <i>CDA</i> or LHDA; or propose $\geq 7,000$ sf of <i>land disturbing activity</i> (3 acres if in Simplified DR).	Projects in Targeted Drainage Review that propose to construct or modify a 12" or larger pipe/ditch, or receive runoff from a 12" or larger pipe/ditch	Redevelopment projects (as defined in 1.1) in Targeted Drainage Review that propose \$100,000 or more of improvements to an existing high-use site
SINGLE-FAMILY RESIDENTIAL BUILDING PERMITS (SFRs)	Targeted Drainage Review ONLY	<ul style="list-style-type: none"> • TIR Sections 1, 2, and 6 (minimum) • Simplified Site ESC Plan⁽³⁾ and SWPPS Plan • Site Improvement Plan⁽⁵⁾. 	<ul style="list-style-type: none"> • TIR Sections 1, 2, 3, 5, 6, 7, and 8 (minimum) • Simplified Site ESC Plan⁽³⁾ and SWPPS Plan • ESC Plan⁽⁴⁾ for conveyance work • Site Improvement Plan⁽⁵⁾ 	N/A
& SHORT PLATS	Targeted Drainage Review COMBINED WITH Simplified Site Drainage Review	<ul style="list-style-type: none"> • TIR Sections 1, 2, and 6 (minimum) • Simplified Site ESC Plan⁽³⁾ and SWPPS Plan • Site Improvement Plan⁽⁵⁾ 	<ul style="list-style-type: none"> • TIR Sections 1, 2, 3, 5, 6, 7, and 8 (minimum) • Simplified Site ESC Plan⁽³⁾ • ESC Plan⁽⁴⁾ for conveyance work • Site Improvement Plan⁽⁵⁾ 	N/A
OTHER PROJECTS OR PERMITS	Targeted Drainage Review ONLY	<ul style="list-style-type: none"> • TIR Sections 1, 2, 6, and 8 (minimum) • ESC Plan⁽⁴⁾ and SWPPS Plan for any site disturbance work • Site Improvement Plan⁽⁵⁾ 	<ul style="list-style-type: none"> • TIR Sections 1, 2, 3, 5, 6, 7, and 8 (minimum) • ESC Plan⁽⁴⁾ and SWPPS Plan for any site disturbance work • Site Improvement Plan⁽⁵⁾ 	<ul style="list-style-type: none"> • TIR Sections 1, 2, 4, 8, and 10 (minimum) • ESC Plan⁽⁴⁾ and SWPPS Plan for any site disturbance work • Site Improvement Plan⁽⁵⁾

Notes:

⁽¹⁾ The above plan elements are considered the recommended minimum for most development cases in Targeted Drainage Review. The Development Review Engineer may add to these elements if deemed necessary for proper drainage review. Pre-design meetings with the **Development Review Engineer** are recommended to identify all required elements.

⁽²⁾ For more detailed descriptions of project categories, see Section 1.1.2.2. If the proposed project has the characteristics of more than one category, the plan elements under each applicable category shall apply.

⁽³⁾ Simplified site ESC plans are an element of the simplified site drainage plan as explained in the *Simplified Site Drainage Requirements* booklet (detached Appendix C).

⁽⁴⁾ ESC plans shall meet the applicable specifications detailed in Section 2.3.1.3

⁽⁵⁾ Site improvement plans shall meet the applicable specifications detailed in Section 2.3.1.2. The Development Review Engineer may allow modified site improvement plans as described in Section 2.3.1.2.

2.4 PLANS REQUIRED AFTER DRAINAGE REVIEW

This section includes the specifications and contents required of those plans submitted at the end of the permit review process or after a permit has been issued.

2.4.1 PLAN CHANGES AFTER PERMIT ISSUANCE

If changes or revisions to the originally approved engineering plans require additional review, the revised plans shall be submitted to the Permit Center as a Plan Revision for approval prior to construction. The plan change submittals shall contain all of the following in PDF format:

- The appropriate Revision form(s).
- The revised TIR or addendum.
- The engineering plans.
- Other information needed for review.

2.4.2 FINAL CORRECTED PLAN SUBMITTAL

During the course of construction, changes to the approved engineering plans are often required to address unforeseen field conditions or design improvements. Once construction is completed, it is the applicant's responsibility to submit to the Economic and Community Development Department a **final corrected plan** (“as-builts”), which is an engineering drawing that accurately represents the project as constructed. These corrected drawings must be professionally drafted revisions applied to the original approved plan, excluding the CSWPP plan, and must include all changes made during the course of construction; the ESC plan, however, should not be included. The final corrected plan must be stamped, signed, and dated by a licensed *civil engineer* registered in the State of Washington. A CAD drawing file (.dwg) of the final corrected plan must be submitted along with paper copies. The CAD file must contain all the pages of the plan set for road and drainage infrastructure, but need not contain other sheets. A **final corrected TIR**, updated to include all changes made to the originally approved TIR during the course of construction, must be submitted with the final corrected plan. In addition to any design changes and supporting calculations and documentation, the final corrected TIR shall include a final updated Stormwater Facility Summary Sheet (see Reference 8-D) and signed/recorded copies of all required easements and declarations of covenant. A copy of any required Landscape Management Plan (see Section 2.3.1.5) shall accompany the plans and TIR. The electronic copy of the final corrected TIR may be in .pdf or other approved format.

2.4.3 FINAL PLAT, SHORT PLAT, AND BINDING SITE PLAN SUBMITTALS

In addition to the requirements of the Economic and Community Development Department, submittals for final recording of subdivisions and short plats must include the following information:

1. Indicate **dimensions** of all easements, tracts, building setbacks, tops of slopes, wetland boundaries, and floodplains.
2. Include **pertinent restrictions** as they apply to easements, tracts, and building setback lines.
3. Include the **dedication and indemnification clause** as provided in Reference Section 8-G accompanying Chapter 5 of the Kent Design and Construction Standards.
4. State the **maximum amount of added impervious surface** and **proposed clearing per lot** as determined through engineering review. The maximum amount of impervious surface may be expressed in terms of percentage of lot coverage or square feet.

5. Specify roof downspout controls by lot based on the “Sizing Credits for Roof Downspout Controls” (see Section 1.2.3.2) as determined through engineering review and approval.
6. For a plat or short plat, record a note conditioning single-family residential permit approval on compliance with approved roof downspout controls (see notes in Section 5.1).

Include a recorded **declaration of covenant and grant of easement** for each lot on which flow control BMPs are installed or stipulated per Core Requirement 9, Section 1.2.9.4.1, and each lot for which flow control BMPs are installed in a separate dedicated tract per Section 1.2.9.4.1.

CHAPTER 3

HYDROLOGIC ANALYSIS AND DESIGN



CITY OF KENT

Surface Water Design Manual

2022

CHAPTER 3	
Hydrologic Analysis and Design.....	3-1

3 HYDROLOGIC ANALYSIS AND DESIGN

The City of Kent has made no changes to Chapter 3 of the 2021 King County Surface Water Design Manual. Chapter 3 of the 2016 King County Surface Water Design Manual shall be used for all proposals in the city of Kent.

CHAPTER 4

CONVEYANCE SYSTEM ANALYSIS AND DESIGN



CITY OF KENT

Surface Water Design Manual

2022

CHAPTER 4

Conveyance System Analysis and Design	4-1
4.1 Route Design Easment Requirements.....	4-1
4.1.2 Easment And Setback Requirements.....	4-1
4.2 Pipes, Outfalls, and Pumps	4-2
4.2.1 Pipe Systems.....	4-2
4.2.2 Outfall Systems.....	4-8
4.3 Culverts And Bridges.....	4-8
4.3.1 Culverts.....	4-8

4 CONVEYANCE SYSTEM ANALYSIS AND DESIGN

The City of Kent has made the following revisions to Chapter 4 of the 2021 KCSWDM. Apart from these changes, the King County version of Chapter 4 applies for proposals in the City of Kent.

4.1 ROUTE DESIGN EASEMENT REQUIREMENTS

4.1.1 EASEMENT AND SETBACK REQUIREMENTS

This section shall read as follows:

Permanent onsite exclusive Easements for access, maintenance, and construction are required for all public and private stormwater systems serving more than one property located outside of public right-of-way. Private improvements such as buildings, fences, garages, carports, retaining walls, utilities, signs, light standards, etc. are not allowed in these easements. Where an encroachment occurs, the developer shall remove and relocate the conflicting private improvements. Easements shall be accessible by construction equipment used to operate and maintain these facilities. When Easements are required, then legal descriptions for same shall be submitted with a professional land surveyor stamp thereon. Also, a current title report covering the properties to be encumbered by the Easements shall accompany said description. Under no circumstances shall a Bill of Sale be placed on the City Council agenda for action until all Easements have been approved and recorded.

When offsite Easements and/or onsite Easements for the extension of approved comprehensive stormwater plans are required, these shall be approved and recorded prior to holding any preconstruction meeting. The same conditions shall apply regarding legal descriptions and title reports.

A. Easements

The minimum easement widths are as follows:

1. Storm drain pipelines (under 10 feet deep) – 15 feet wide.
2. Storm drain pipelines (10 –15 feet deep) – 20 feet wide. Note: large diameter or deeper sewers may require wider easements as determined necessary by the Director.
3. Access and/or maintenance roads are required to all retention/detention facilities, control manholes, and other drainage structures. The minimum roadway width shall be 12 feet. The road shall be paved with an all-weather surface, and the pavement shall be designed to support a HS-20 loading maintenance vehicle.
4. The Easements for detention facilities or other structures shall extend a minimum of 12 feet around the outside of the facility, and shall include access Easements as well.

B. Right-of-way

Where possible, utility extensions shall be located within City Right-of-way. When possible storm drainage Retention/Detention facilities shall be located adjacent to City Right-of-way.

Work inside County and State Right-of-way requires use permits from the appropriate agencies. County and State Right-of-way Permits must be obtained by the developer/owner.

4.2 PIPES, OUTFALLS, AND PUMPS

4.2.1 PIPE SYSTEMS

4.2.1.1 DESIGN CRITERIA

Acceptable Pipe Sizes – This section is replaced with the following:

“The minimum diameter of storm drain approved for mainline conveyance systems, or for driveway culverts, shall be 12 inches. Minor laterals and connections to catch basins may be 8 inches in diameter if approved by the City. The minimum diameter acceptable for private systems shall be 8 inches, excluding downspouts.”

Allowable Pipe Materials – This section is replaced with the following:

The designer shall have the option of constructing storm sewers, drains, and culverts of the type of pipe listed below within the limits specified. It is not necessary that all pipe on the project be of the same type; however, all contiguous pipe shall be of the same type.

Type of Pipe	Minimum Cover (ft) (from top of bell) (See Note 1)	Public Systems
PCP (Bell & spigot Gasket joint)	2	Yes
RCP	1	Yes
HDPE (solid wall only)	1.5	Yes, see Note 2 for exemption
Polypropylene Pipe (PP)	See Note 3	Yes, see Note 2 for exemption
PVC SDR 35	3	Yes, see Note 2 for exemption
PVC SDR 21	1.5	Yes, See Note 2 for exemption
Ductile Iron	0.5	Yes
Ribbed PVC	2	Yes, see Note 2 for exemption

NOTES:

1. These are minimum depths. Actual depths must meet design loading requirements including maximum depths specified by the pipe manufacturer. Pipe cover in areas not subject to vehicular loads may be reduced to 3 inch minimum. . Regardless of stated minimum cover, the designer shall mitigate for pipe buoyancy.
2. HDPE, PVC and PP pipes shall not be used as driveway culvert and on pipe runs where one or both ends are not terminated at a manhole or catch basin.
3. Minimum cover in traffic areas for 12-inch through 48-inch diameter pipes shall be 2 ft, and for 60-inch diameter pipe shall be 3 ft. Regardless of stated minimum cover, the designer shall mitigate for pipe buoyancy.
4. All materials used for construction of storm drainage systems and appurtenances shall be new and undamaged. All materials used shall be subject to inspection by the City prior to use. The contractor shall provide the City with shop drawings, manufacturer’s

specifications, and certificates of materials as requested.

The materials referred to herein, shall conform to the applicable provisions of the Standard Specifications and the manufacturer's recommended installation procedures.

1. Plain Concrete Storm Sewer Pipe (PCP) – All nonreinforced concrete pipe shall be ASTM C14-81 Class II or better with gasketed joints. Joints for concrete pipe shall use rubber gaskets per ASTM C443. The maximum diameter for unreinforced pipe shall be 12 inches.
2. Reinforced Concrete Pipe (RCP) – All reinforced concrete pipe shall be ASTM C76-85a Class IV or as specified. Elliptical and arch pipe shall be reinforced per ASTM C507 and ASTM C506 accordingly. Joints for reinforced concrete pipe shall use rubber gaskets per ASTM C443.
3. Protective Treatment – All steel pipe shall be coated with a protective asphalt treatment. The minimum acceptable protective treatment shall be APWA Treatment 1.
4. PVC Pipe – PVC pipe conforming to ASTM 3034, SDR 35 and SDR 21 with rubber gasket joints may be used where adequate cover can be obtained. Joints shall conform to ASTM D3212 using elastomeric gaskets conforming to ASTM F477.
5. Ribbed PVC – PVC pipe conforming to ASTM F79H/UNI-B-9 with rubber gasket joints may be used where adequate cover can be obtained. Joints shall conform to ASTM D3212 using elastomeric gaskets conforming to ASTM F477.
6. HDPE Pipe – Non-corrugated solid walled High Density Polyethylene Pipe (HDPE) are manufactured from resins meeting the requirements of ASTM D3350 and meeting or exceeding cell classification of 445574C, and a plastic pipe institute (PPI) designation of PE 4710. The pipe shall have a minimum standard dimension ratio (SDR) of 32.5. HDPE pipe shall be joined into a continuous length by using a butt-fusion joint method meeting the requirements of ASTM F2620 and the manufacturer's recommendations.
7. Polypropylene Pipe (PP) – PP Pipe shall conform to the requirements of ASTM F2764 with minimum pipe stiffness of 46 lbs/in./in. when tested in accordance with ASTM D2412. Pipe sizes ranging from 12 inch to 24 inch shall be double-walled and pipe sizes ranging from 30 inch to 60 inch shall be triple-walled. Double-walled pipe shall have a smooth interior surface and annular exterior corrugations, whereas triple-walled pipe shall have a smooth interior and exterior surfaces with annular corrugations in between. Pipe joint shall be a bell and spigot design with double gaskets. Pipe and joint performance verification are field tested in accordance with ASTM F1417 or ASTM F2487. Gaskets shall meet the requirements of ASTM F477 and be installed by the pipe manufacturer. Pipe gaskets shall be shipped covered with a removable protective wrap to ensure the gaskets are free from debris. Pipe bell shall have reinforcement with a polymer composite band installed by the pipe manufacturer.
8. Ductile Iron Pipe – DI pipe shall be Class 50 in accordance with USA Standard A-21.1 (AWWA C-51). All joints shall be push-on mechanical or flanged.

Pipe Alignment – Replace Requirement 1 with the following:

“All storm drains smaller than 36 inches in diameter shall be designed with a straight alignment between manholes or catch basins.

Storm Drainage Manholes

- A. Location – Storm drainage manholes or catch manholes for access are required at the following locations on the conveyance system:
 1. All changes in slope.
 2. Changes in pipe diameter.
 3. Connections of storm pipes from manholes to the conveyance systems that are larger than 24 inches in diameter.

The following exceptions may be connected to conveyance systems that are equal to a 48-inch-diameter pipe using an approved saddle branch:

- a. Connections of storm pipes from catch manholes that are 24 inches and smaller in diameter.
 - b. Connections of storm pipes from catch basins that are 18 inches and smaller in diameter.
4. Changes in alignment.
 5. Distances not greater than 400 feet on pipe runs.
 6. Dissimilar pipe materials and/or change in pipe material.
 7. In a trunk line smaller than 12 inches, at every other catch basin but no greater than 400 feet.
- B. Flow Channels – Where necessary to maintain the hydraulic gradeline, channeled storm drain manholes shall be used. The manhole shall be fully channeled to the crown of the pipe to accomplish smooth flow and minimize turbulence at junctions. Catch or drop section manholes are permitted on the trunk system.
- C. Flow at Transition Manholes – To maintain the energy gradient and the velocity through grade changes and changes in diameter at manholes, the invert of the downstream pipe shall be lowered. A general method to achieve the required drop at manholes is to match crowns of the storm pipes. In cases where slopes are at a minimum, an alternate approach is to use the 0.8 rule. Where possible, a 0.1 foot drop in all manholes is desirable.
- D. Standard Manholes – The minimum diameter of manholes shall be 48 inches and shall be precast reinforced concrete structures. All manholes shall be equipped with safety steps. Larger diameter manholes are required for larger pipelines and special pipe configurations. The following table lists the minimum diameter of manholes for various runs of straight pipelines. (See Standard Details 5-8(a), 5-8(b) and 5-9 in Appendix B of the Kent Design and Construction Standards.)

Pipe Diameter	Manhole Diameter
8 inches – 21 inches	48 inches
24 inches – 36 inches	54 inches
36 inches – 42 inches	72 inches
42 inches – 60 inches	96 inches

Stormwater Inlets

Stormwater inlets, installed to intercept surface runoff, include catch basins, catch manholes, curb inlets, and headwall structures. Catch type inlets are required to trap or minimize silts, sediment, and debris from entering the main drainage systems. Curb type inlets without a drop section are permitted only where approved by the City.

- A. Catch Basin Locations for Street and Roadways – Catch basins or catch manholes shall be installed at these locations:
1. At all street gutterline intersections in such a configuration as to minimize gutter flows through pedestrian crossings.
 2. At locations along gutters so as to provide a maximum gutter flow of 200 feet for street grades up to 3%.
 3. Where Type II catch basins are used for access to the trunk storm sewer, the maximum spacing shall be 400 feet.

4. At all low points of vertical curves and grade breaks.
 5. At the inlet of minor ditches to the drainage system.
- B. The low point of vertical curves or roadway grades require catch basins with through curb inlet to minimize the potential for property damage. Cul-de-sacs located at the low end of roadway grades also require catch basins with through curb inlet. (See Standard Detail 5-2(a) and (b) in Appendix B of the Kent Design and Construction Standards.)
 - C. In all cases, the location, size, and number of catch basins to be installed shall be sufficient to ensure that there is adequate capacity to efficiently collect the stormwater.
 - D. Catch Basin Locations for Private Developments – Catch basins or catch manholes are required at these locations for private developments:
 1. At the junction of private storm drainage systems with City drainage systems.
 2. At adequate locations throughout the development to provide efficient drainage of paved areas and to ensure that surface water runoff to adjacent City streets and private property is minimized.
 3. At locations as required to intercept natural drainage entering the site.

Castings

- A. Manhole frames and covers shall be cast gray iron or ductile iron. All manhole covers located outside the street shall have locking lids. (See Standard Plans in Section 5.9 of the Kent Design and Construction Standards.)
- B. Public catch basin frame and grates shall be ductile iron and bolt down. (See Standard Plans in Section 5.9 of the Kent Design and Construction Standards.)
- C. Public catch basins used in areas not designed to receive surface drainage or where required by the Director shall have ductile iron bolt down frame with solid lid. (See Standard Plans in Section 5.9 of the Kent Design and Construction Standards.)
- D. Public catch basins used in low point of vertical curves or roadway grades and at the low end of roadway grades in cul-de-sacs shall have through curb inlet frame and self-locking vaned grate. (See Standard Plans in Section 5.9 of the Kent Design and Construction Standards.)
- E. Public catch basins used in steep roadway grades of 6% and greater shall have ductile iron self-locking vaned grate with vaned grate frame. (See Standard Plans in Section 5.9 of the Kent Design and Construction Standards.)
- F. Public catch basins used in rolled curb and gutter shall have rolled curb frame and grate. (See Standard Details (See Standard Plans in Section 5.9 of the Kent Design and Construction Standards.)
- G. Block lettering is required on the top surfaces of storm drain castings, and shall read as follows:
 “NO DUMPING! DRAINS TO STREAMS!”

Manhole and Catch Basin Adapters

- A. All aluminum surfaces in contact with the concrete shall be treated to protect from corrosion. The aluminum pipe to be treated shall be cleaned with solvent to remove contaminants. After cleaning, the pipe shall be painted with 2 coats of paint conforming to Federal Specification TT-P-645.
- B. PVC pipe adapters shall be Kor-in-seal type flex joints or sand collars meeting ASTM D-303H-78 SDR35 specifications or other materials as approved by the Director to permit slight differential movement.
- C. Ribbed PVC adapters shall be Ribbed PVC sand collars meeting ASTM D-303H-78 SDR35 specifications. Where the pipe enters square to the manhole or catch basin, double gaskets may be

used. The gaskets must fall within a 1-inch tolerance of the inside and outside face of the wall of the structure.

- D. Double wall Polypropylene Pipe shall use Sanitite HP manhole adapter. Additionally, Polypropylene Pipe (double wall and triple wall) shall use Kor-N-Seal wedge style connector or PSX Direct Drive pipe to manhole connector meeting ASTM C923 or other material as approved by the Director to permit slight differential movement.
- E. All pipe materials other than the above shall be mudded directly into the manholes and catch basins using a smooth 45 degree bevel from the pipe to the structure. The allowable protrusion is 2 inches inside the structure unless otherwise approved by the Director.

Pipe Bedding

Pipe bedding for storm drain and culvert pipe shall be 5/8-inch minus crushed rock. (Pea gravel is not allowed). A continuous and uniform bedding shall be provided in the trench for all buried pipe. Bedding material shall be tamped in layers around the pipe and to a sufficient height above the pipe to adequately support and protect the pipe to 95% compaction ASTM D-1557, in accordance with the standard specifications and details and in conformance with the following gradation:

Sieve Size	Passing
3/4 Inch	100%
5/8 Inch	95 – 100%
1/4 Inch	45 – 65%
U.S. No. 40	6 – 18
U.S. No. 200	7.5 Max.
% Fracture	75 Min.
Sand Equivalent	40 Min.

L.A. wear 500 rev. 35% Max., Degradation 25% min. Free from wood waste, bark, and other deleterious material.

Bedding shall be placed 6 inches under or around the pipe and 6 inches over the pipe where, in the opinion of the Director, existing material is found unsuitable. The pipe shall be protected from damage when compacting. At least 2 feet of cover is required over the pipe prior to using heavy compaction equipment.

Where determined necessary by the Director, ballast material shall be used below bedding to stabilize the trench. Ballast shall conform to the requirements of Pipe Bedding and Foundation Material in Section 3.20.A of the City of Kent Design and Construction Standards.

Backfill

Pipe trench backfill shall be in accordance with Section 4.7.F of the City of Kent Design and Construction Standards unless otherwise approved by the Director.

Cleaning

All storm drain pipe including the downstream system shall be thoroughly cleaned to remove any solids or construction debris that may have entered the pipe system during construction.

The Contractor shall be responsible to ensure that materials flushed from the storm drain are trapped, removed, and do not enter the downstream drainage system.

Storm Drain Marking

The pavement adjacent to all new catch basins shall be marked with one of the standard pollution prevention buttons shown below. The Contractor is responsible for installation of the buttons. Privately maintained catch basins shall use marker b) and must be purchased by the contractor. Markers for publicly owned catch basins, marker a), will be provided by the City. Public catch basin markers shall not be used for privately maintained catch basins.



a) Public catch basin marker



b) Private catch basin marker

Repairs

All storm drain system installations shall be new and undamaged. Repairs by grouting or collars are not acceptable for new piping systems. The contractor shall bear all costs for correction of deficiencies.

Television Inspection

All new City storm drain extensions, 24 inches in diameter and smaller shall be TV camera inspected by the City prior to acceptance. All construction must be completed and approved by the inspector prior to the TV inspection. The manholes and catch basins must be set to grade, channeled, and grade rings set in place prior to TV inspection. Castings and the top grade ring must be removed for paving and grouted in place after paving.

It is the responsibility of the contractor to string each storm main when required prior to the inspection. The string shall be a nylon cord of sufficient strength for the City equipment.

Pipe Design Between Structures – Add the following to the list of requirements:

4. Storm sewers with design velocities greater than 10 fps shall be designed with energy dissipation structures as deemed necessary by the City. Pipes installed at a slope greater than 20% require pipe anchors.

Spill Control – Delete the following item:

- e) “**active spill control plan.**” This is not an acceptable option for spill control in the City of Kent.

4.2.2 OUTFALL SYSTEMS

4.2.2.1 DESIGN CRITERIA

General – Add the following to the list of requirements:

7. Points of discharge from culverts and storm sewers into ditches and swales 15% or greater in grade shall require the design and installation of engineered energy dissipators.

4.3 CULVERTS AND BRIDGES

4.3.1 CULVERTS

4.3.1.1 DESIGN CRITERIA

General – Add the following to the list of requirements:

3. The minimum diameter of culvert for roadside ditches or other installations shall be 12 inches. Larger diameter culverts shall be installed where required by appropriate hydraulic analysis.

Headwater – Requirement 3 is revised to read: “The maximum headwater elevation at design flow shall be at least 12 inches below finished grade.”

Inlets and Outlets – **Requirement 4 is revised** to apply to all pipes larger than 12 inches. **Requirement 5 is revised** to apply to all new culverts unless deemed unnecessary by the City

CHAPTER 5

FLOW CONTROL DESIGN



CITY OF KENT

Surface Water Design Manual

2022

CHAPTER 5

Flow Control Design	5-1
5.1 Detention Facilities	5-1
5.1.1 Detention Ponds.....	5-1
5.1.2 Detention Tanks.....	5-2
5.1.5 Parking Lot Detention.....	5-3
5.1.6 Roof Detention.....	5-3

5 FLOW CONTROL DESIGN

The City of Kent has made the following revisions to Chapter 5 of the 2021¹ KCSWDM. Apart from these changes, the King County version of Chapter 5 applies for proposals in the City of Kent.

5.1 DETENTION FACILITIES

5.1.1 DETENTION PONDS

5.1.1.1 DESIGN CRITERIA

General - The following items are added to this section:

6. All retention/detention ponds shall have a minimum of one foot free board above the maximum design water surface elevation.
7. Outlets of all detention ponds shall be provided with suitable debris barriers designed to protect the outlet from blockage or plugging.
8. The site and grading plans for open ponds shall clearly denote all elevations, dimensions, cross-section views (a minimum of one through each direction), soil preparation requirements and other information necessary to construct the system as designed. The design plans shall also denote that the design engineer shall verify the pond volume and construction prior to landscaping.
9. All ponds shall provide for the energy reduction of incoming flows.

Side Slopes – This section is replaced with the following:

1. Side slopes for earth-lined ponds shall not exceed three feet horizontal to one foot vertical, unless specifically approved by the Director. See Section 6.4.4 for side slope requirements for internal berms in combined ponds and wetponds.
2. Ponds constructed with rock walls or retaining walls shall be designed by a licensed structural or civil engineer registered in the State of Washington. Walls shall not exceed 6 feet in height.
3. **Pond walls** may be vertical retaining walls, provided: (a) they are constructed of reinforced concrete per Section 5.1.3; (b) a fence is provided along the top of the wall; (c) at least 25% of the pond perimeter will be a vegetated soil slope not steeper than 3H:1V in addition to one access for maintenance equipment at a maximum 6:1 slope; and (d) the design is stamped by a licensed structural civil engineer.
4. Fencing is required for all ponds unless otherwise approved by the Engineer/Director.

Embankments – Requirements 1 and 2 have been revised as follows and item 7 has been added:

1. Any embankment for a pond in excess of four feet must be designed by a licensed civil engineer and approved by the City.

2. The top width of the berm shall be 15 feet, unless otherwise approved by the City. The outer edge of the berm slope may be located within the outer 10 feet of critical area buffers or within pond landscape setbacks, as long as the landscaping on the berm and slope within those buffers and setbacks meets the geotechnical engineer's requirements.
7. A licensed civil engineer experienced in soil mechanics shall inspect and certify the construction of the berm.

Fencing – This section is replaced with the following:

1. Fencing is required for all ponds unless otherwise approved by the Engineer/Director.
2. Fences shall be 6 feet in **height**. For design examples, see WSDOT Standard Plan L-2, Type 1 or Type 3 chain link fence. **Fence material** shall be vertical metal balusters, 9 gauge stainless steel, aluminized steel, or galvanized steel fabric. If galvanized, bonded vinyl coating is required. For steel fabric fences, the following apply:
 - f) **Vinyl coating** shall be compatible with the surrounding environment (e.g., green in open, grassy areas and black or brown in wooded areas). All posts, cross bars, and gates shall be coated the same color as the vinyl clad fence fabric.
 - g) **Fence posts and rails** shall conform to WSDOT Standard Plan L-2 for Types 1, 3, or 4 chain link fence, except that if galvanized, they must be coated with bonded vinyl.
3. **Access road gates** shall be 16 feet in width consisting of two swinging sections 8 feet in width. Additional vehicular access gates may be required as needed to facilitate maintenance access.
4. **Pedestrian access gates** (if needed) shall be 4 feet in width.
5. For fences to be maintained by the City, fencing and gates shall be per details 5-22 and 5-23 of the KDCS.

Signage – This section is replaced with the following:

Detention ponds, infiltration ponds, wetponds, and combined ponds to be maintained by the City of Kent or privately maintained shall have a sign placed for maximum visibility from adjacent streets, sidewalks, and paths. The sign shall meet the design installation requirements illustrated in standard plan 5-40 of the Kent Design and Construction Standards Manual.

Right-of-Way – Requirement 2 has been revised as follows and item 3 has been added:

2. All storm water retention/detention systems and outlet control structures that service more than one legally defined property are required to be located within a tract or recorded storm drainage easement. In some cases, the City may approve locating detention piping within the street right-of-way. If the detention facilities are not located adjacent to the roadway, a 12- foot-wide, all-weather surfaced access road shall be constructed to the facility. This access road shall be located within a tract or easement and shall provide for unobstructed ingress and egress to the facility.
3. A written restriction shall be added to final plat drawings that "Prior approval must be obtained from the Department of Public Works before any structures, fill or obstructions, including fences, are located within any drainage easement or tract.

5.1.2 DETENTION TANKS

5.1.2.1 DESIGN CRITERIA

Materials – The following is added to this section:

Corrugated steel storage pipes shall be uniformly coated with APWA Treatment 1 asphalt or better. Corrugated aluminum or concrete pipe may be substituted without asphalt treatment. The use of zinc chromate primer is prohibited unless approved by the City.

The Fire Authority shall be consulted during design of any underground facilities to ensure that outrigger placement (pointload) requirements are met.

Stability – The following is added to this section:

The concrete structures shall be designed by a civil or structural engineer registered in the State of Washington, and be designed for at least HS-20 traffic loading conditions. Concrete vaults shall be designed in accordance with King County Surface Water Management Standard Details for detention vaults. A City building permit is required for vault structures.

The Fire Authority shall be consulted during design of any underground facilities to ensure that outrigger placement (pointload) requirements are met.

5.1.5 PARKING LOT DETENTION

Replace this section with the following:

1. Maximum depth for surface storage in parking lots shall be as follows:
 - a. Commercial/multi-family parking and maneuvering areas – six inches.
 - b. Industrial truck loading/maneuvering areas – 18 inches.
2. Parking lots designed for detention shall not exceed slopes of seven percent in areas of vehicular parking or maneuvering.
3. All parking lot ponds shall be designed and constructed in such a manner so as to provide 0.50 feet of freeboard between the maximum water surface elevation and adjacent driveways, landscaping or adjacent properties.
4. The maximum water surface elevation of any parking lot pond shall be a minimum of six inches below the finished floor elevation of adjacent buildings. All ponding systems shall be designed to go to overflow conveyance prior to flooding structures.
5. Where parking lot ponding is to be utilized, the site grading and paving plans shall clearly denote all critical elevations, ponding, dimensions, and any other necessary information to construct the detention pond as designed. The design plan shall indicate that the respective details are critical for the storm drainage detention system operation and that the site grading must be verified.

5.1.6 ROOF DETENTION

Add the following items

6. All rooftop detention facilities shall be provided with overflow scupper drains at the maximum water surface elevation.

7. Rooftop detention rings shall be installed in accordance with the manufacturer's specifications and shall be designed to restrict rooftop runoff rates not to exceed two gallons per minute per 1000 square feet of roof area.

CHAPTER 6

WATER QUALITY DESIGN



CITY OF KENT

Surface Water Design Manual

2022

CHAPTER 6	
Water Quality Design	6-1
6.2 General Requirements For WQ Facilities.....	6-1
6.2.3 Slopes, And Embankmetns.....	6-1
6.7 Proprietary Facility Designs.....	6-1

6 WATER QUALITY DESIGN

The City of Kent has made the following revisions to Chapter 6 of the 2021 KCSWDM. Apart from these changes, the King County version of Chapter 6 applies for proposals in the City of Kent.

6.2 GENERAL REQUIREMENTS FOR WQ FACILITIES

USE OF MATERIALS

This section is replaced with the following:

Galvanized materials in stormwater facilities and conveyance systems is discouraged. If galvanized materials are used, bonded vinyl coating is required. Where other metals, such as aluminum or stainless steel, or plastics are available, they shall be used.

6.2.3 SLOPES, AND EMBANKMENTS

SIDE SLOPES, FENCING, AND EMBANKMENTS – Add the following to the list of requirements:

“Any above-ground stormwater facility will be screened from public right of way and adjacent property per city of Kent underlying zoning perimeter buffer requirements.”

Requirement 4 is replaced with the following:

4. Non-residential commercial and industrial facilities that are privately owned and maintained, shall follow the fencing requirements of this manual as well as any fencing requirements in other codes or regulations.

6.7 PROPRIETARY FACILITY DESIGNS

This section is replaced with the following:

Water quality facilities other than those identified in Chapter 6 are allowed on an experimental basis if it can be demonstrated they are likely to meet the pollutant removal goal for the applicable receiving water. Use of such facilities requires an experimental design adjustment to be approved by Kent according to Section 1.4, “Adjustment Process.”, Experimental and proprietary BMPs may be allowed to provide pretreatment for filter BMPs or as the second WQ facility in the Two-Facility Treatment Train option. Applications will be reviewed on a case-by-case basis. For an experimental or proprietary BMP to be approved, it must be approved for use through the Washington Department of Ecology’s TAPE Program.

The general use level designation (GULD) of the TAPE Program confers a general acceptance for the specified applications (land uses). Manufactured treatment devices with a GULD may be used for new development, re-development, or retrofit situations anywhere in Washington, subject to conditions that Ecology places within the use designation document. Manufactured treatment devices with a GULD can have an unlimited number of installations without the need for an adjustment.

APPENDIX



CITY OF KENT Surface Water Design Manual 2022

APPENDIX A

Appendix A - Maintenance Requirements For Flow Control, Conveyance, And Facilities.. **A-Error! Bookmark not defined.**

APPENDIX B

Appendix B - Master Drainage Plan Objectives, Criteria, Components, And Review Process **A-Error! Bookmark not defined.**

APPENDIX C

Appendix C – Simplified Drainage Requirements **A-Error! Bookmark not defined.**

APPENDIX D

Appendix D – Construction Stormwater Pollution Prevention..... **A-Error! Bookmark not defined.**

D.1 General CSWPP Requirements **A-Error! Bookmark not defined.**

APPENDIX A

MAINTENANCE REQUIREMENTS FOR FLOW CONTROL, CONVEYANCE, AND WATER QUALITY FACILITIES



CITY OF KENT Surface Water Design Manual 2022

APPENDIX A - MAINTENANCE REQUIREMENTS FOR FLOW CONTROL, CONVEYANCE, AND WATER QUALITY FACILITIES

The City of Kent has made no changes to Appendix A of the 2021 KCSWDM. Users should refer to the County document for guidance on the thresholds and standards for maintenance of all flow control facilities and BMP's, conveyance systems, and water quality facilities required in this manual.

APPENDIX B

MASTER DRAINAGE PLAN OBJECTIVES, CRITERIA, COMPONENTS AND REVIEW PROCESS



CITY OF KENT Surface Water Design Manual 2022

The City of Kent does not adopt Appendix B of the 2021 KCSWDM.

APPENDIX B - MASTER DRAINAGE PLAN OBJECTIVES, CRITERIA, COMPONENTS, AND REVIEW PROCESS

The City of Kent does not adopt Appendix B of the 2021 KCSWDM.

APPENDIX C

SIMPLIFIED DRAINAGE REQUIREMENTS



CITY OF KENT

Surface Water Design Manual

2022

APPENDIX C – SIMPLIFIED DRAINAGE REQUIREMENTS

The City of Kent has made no changes to Appendix C of the 2021 KCSWDM. Users should refer to the County document for guidance on simplified drainage requirements for smaller projects that qualify for Simplified Drainage Review.

APPENDIX D

CONSTRUCTION STORMWATER POLLUTION PREVENTION



CITY OF KENT Surface Water Design Manual 2022

APPENDIX D – CONSTRUCTION STORMWATER POLLUTION PREVENTION

The City of Kent has made one minor change to Appendix D of the 2021 KCSWDM which describes the required measures to be implemented during construction to prevent discharges of sediment-laden runoff from the project site. It also describes effective management practices for spill control and chemical pollutants used during construction that may be needed to supplement the required erosion and sedimentation control measures. Apart from this change, the King County version of Appendix D applies for proposals in the City of Kent. The City's change to the County document is as follows:

D.1 GENERAL CSWPP REQUIREMENTS

Erosion and Sediment Control Measures, Sediment Retention (*page D-58 of the 2016 KCSWDM*) -

The following item is added to this section:

TEMPORARY CATCH BASIN PIPE DETAIL

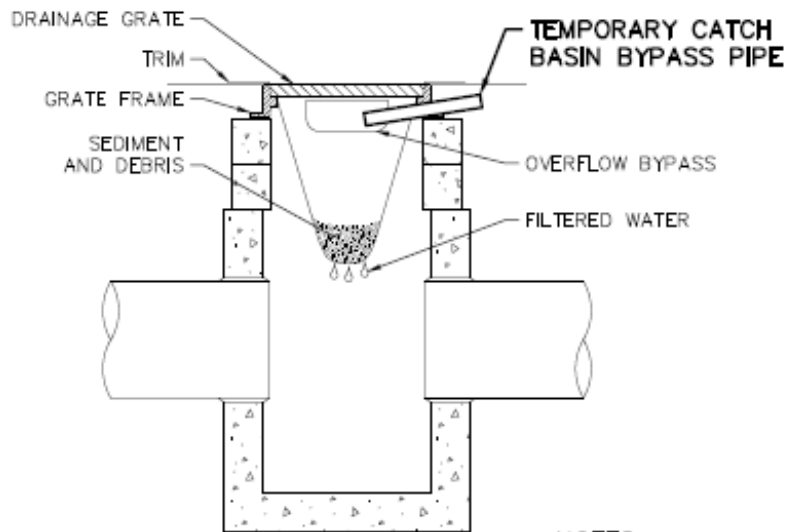

SECTION VIEW

NOTES:

1. TO PREVENT STANDING WATER, INSTALL BYPASS PIPE AS SHOWN.
2. INSERT BYPASS PIPE INTO OVERFLOW OF CATCH BASIN USING 1" DIAMETER PVC OR GREATER.
3. REMOVE BYPASS PIPE PRIOR TO INSTALLATION OF FINAL LIFT OF PAVEMENT.
4. ENSURE REMAINING HOLE IS REPAIRED.

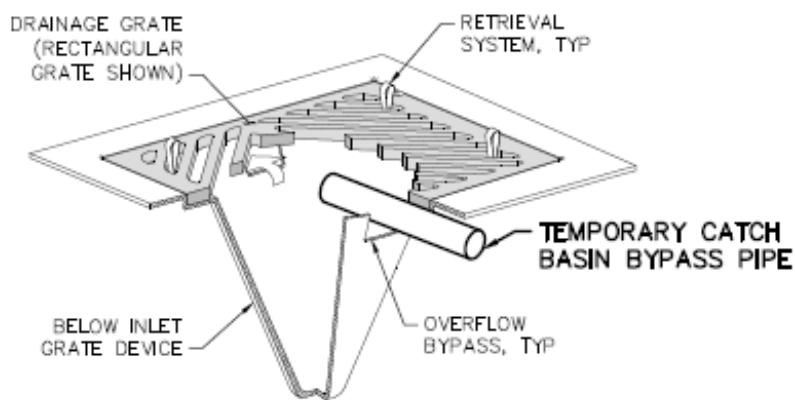

ISOMETRIC VIEW

TEMPORARY CATCH BASIN BYPASS PIPE DETAIL NOT TO SCALE

REFERENCES



**CITY OF KENT
Surface Water Design Manual
2021**

REFERENCES

The 2021 King County Surface Water Design Manual includes many reference materials. Some references are for guidance and some are required worksheets to be utilized during the development application, review, and approval process. The applicant is responsible to ensure that the most current materials are used in preparing a permit application.

The City of Kent accepts certain reference materials as written in the 2016 King County Surface Water Design Manual. Other references are not applicable in Kent. Some reference materials have been revised to reflect Kent-specific forms or development procedures. References from the King County Manual are identified below along with how they are to be utilized in Kent (in **bold**).

Six separate maps are attached that must be utilized during the Development process (See Table of Contents for list).

REFERENCES

1. KCC 9.04 – Surface Water Runoff Policy

Refer to Kent City Code sections 7.05 and 7.07

2. Adopted Critical Drainage Areas

None currently listed

3. Other Adopted Area Specific Drainage Requirements

Not applicable

4. Other Drainage Related Regulations and Guidelines

4.A. Grading Code Soil Amendment Standard

See Kent Design and Construction Standards and Kent City Code section 15.07

4.B. Clearing & Grading Seasonal Limitations

See Kent Design and Construction Standards and Appendix D (Construction Stormwater Pollution Prevention)

4.C. Landscape Management Plan Guidelines

Utilize Reference 4.C from the King County Surface Water Design Manual

4.D. Shared Facility Maintenance Responsibility Guidance

Refer to Kent Design and Construction Standards

5. Wetland Hydrology Protection Guidelines

Utilize Reference 5 from the King County Surface Water Design Manual in consultation with city review staff

6. Hydrologic/Hydraulic Design Methods

6.A. Infiltration Rate Test Methods

Utilize Reference 6.A from the King County Surface Water Design Manual as applicable and in consultation with city review staff

6.B. Pond Geometry Equations

Utilize Reference 6.B from the King County Surface Water Design Manual as applicable and in consultation with city review staff

6.C. Introduction to Level Pool Routing

Utilize Reference 6.C from the King County Surface Water Design Manual as applicable and in consultation with city review staff

6.D. Supplemental Modeling Guidelines

Utilize Reference 6.D from the King County Surface Water Design Manual as applicable and in consultation with city review staff

7. Engineering Plan Support

7.A. King County Standard Map Symbols

Refer to Kent Design and Construction Standards

7.B. Standard Plan Notes and Example Construction Sequence

Refer to Kent Design and Construction Standards

7.C. Stormfilter Facility Access and Cartridge Configuration

Utilize Reference 7.C from the King County Surface Water Design Manual as applicable and in consultation with city review staff

8. Forms and Worksheets

8.A. Technical Information Report (TIR) Worksheet

Utilize the TIR Worksheet provided in reference 8.A of the King County Surface Water Design Manual or a TIR Worksheet provided by city review staff

8.B. Offsite Analysis Drainage System Table

Utilize the Offsite Analysis Drainage System Table from the King County Surface Water Design Manual or an Offsite Analysis Drainage System Table provided by city review staff

8.C. Water Quality Facility Sizing Worksheets

Utilize the Water Quality Facility Sizing Worksheets provided in the King County Surface Water Design Manual

8.D. Flow Control and Water Quality Facility Summary Sheet and Sketch

Utilize the Flow Control and Water Quality Facility Summary Sheet and Sketch provided in the King County Surface Water Design Manual

8.E. CSWPP Worksheet Forms

Utilize the CSWPP Worksheet Forms provided in the King County Surface Water Design Manual as applicable and in consultation with city review staff

8.F. Adjustment Application Form and Process Guidelines

Utilize Design and Construction Standards Deviation Request Application Form and Process Guidelines provided by the Kent Economic and Community Development Department Permit Center or Development Review divisions

8.G. Dedication and Indemnification Clause - Final Recording

Utilize Dedication and Indemnification Clause - Final Recording language as required by the Kent Economic and Community Development Department Permit Center or Development Review divisions

8.H. Bond Quantities Worksheet

Utilize Engineer's Cost Estimate as provided in Appendix D of the Kent Design and Construction Standards

8.I. Maintenance and Defect Agreement

Utilize Maintenance and Defect Agreements provided by the Kent Economic and Community Development Department Permit Center or Development Review divisions

8.J. Drainage Facility Covenant

Utilize Drainage Facility Covenant format as required by the Kent Economic and Community Development Department Permit Center or Development Review divisions

8.K. Drainage Release Covenant

Utilize Drainage Release Covenant as applicable and as directed by the Kent Economic and Community Development Department Permit Center or Development Review divisions

8.L. Drainage Easement

Utilize Drainage Easement standard procedure and format as applicable and as directed by the Kent Economic and Community Development Department Permit Center or Development Review divisions

8.M. Flow Control BMP Covenant and BMP Maintenance Instructions (Recordable format)

Utilize Reference 8.M as provided in the King County Surface Water Design Manual as applicable and as directed by the Kent Economic and Community Development Department Permit Center or Development Review divisions

8.N. Impervious Surface Limit Covenant

Utilize Reference 8.N as provided in the King County Surface Water Design Manual as applicable and as directed by the Kent Economic and Community Development Department Permit Center or Development Review divisions

8.O. Clearing Limit Covenant

Utilize Reference 8.O as provided in the King County Surface Water Design Manual as applicable to preserve native vegetative areas and as directed by the Kent Economic and Community Development Department Permit Center or Development Review divisions

8.P. River Protection Easement

Utilize Reference 8.P as provided in the King County Surface Water Design Manual as applicable and as directed by the Kent Economic and Community Development Department Permit Center or Development Review divisions

8.Q. Leachable Metals Covenant

Utilize Reference 8.Q as provided in the King County Surface Water Design Manual as applicable and as directed by the Kent Economic and Community Development Department Permit Center or Development Review divisions

9. Interim Changes to Requirements

9.A. Blanket Adjustments

Blanket Adjustments will be added by reference to this manual and posted on the City's website. As of January 2017, there are no applicable Blanket Adjustments to this manual.

9.B. Administrative Changes

Administrative Changes will be added by reference to this manual and posted on the City's website. As of January 2017, there are no applicable Administrative Changes to this manual.

10. Kent-Identified Water Quality Problems

None at this time. Refer to Washington Department of Ecology's Impaired Waterbody list for state listed water quality problems.

11. Materials

11.A. (VACANT)

Not applicable

11.B. (VACANT)

Not applicable

11.C. Bioretention Soil Media Standard Specifications

Utilize the Bioretention Soil Media Standard Specifications provided in the King County Surface Water Design Manual as applicable

11.D (VACANT)

Not applicable

11.E. Roofing Erodible or Leachable Materials

Utilize the Roofing Erodible or Leachable Materials guidance provided in the King County Surface Water Design Manual as applicable

12. (VACANT)

Not applicable

13. (VACANT)

Not applicable

14. Supplemental Approved Facilities

14.A. Approved Proprietary Facilities

Utilize the Approved Proprietary Facilities Specifications provided in the King County Surface Water Design Manual as applicable

14.B. Approved Public Domain Facilities

None at this time

MAPS



CITY OF KENT Surface Water Design Manual 2022

MAPS

Erosion Hazard Areas	M-1
Flow Control Applications.....	M-2
Landslide Hazard / Landslide Hazard Drainage Areas	M-3
Soils Wellhead Areas.....	M-4
Water Quality Applications	M-5
Wetlands	M-6
Lower Mill Creek Regulatory Area	M-7
King County 100 Year 7 Day Isopoluvial Map.....	M-8

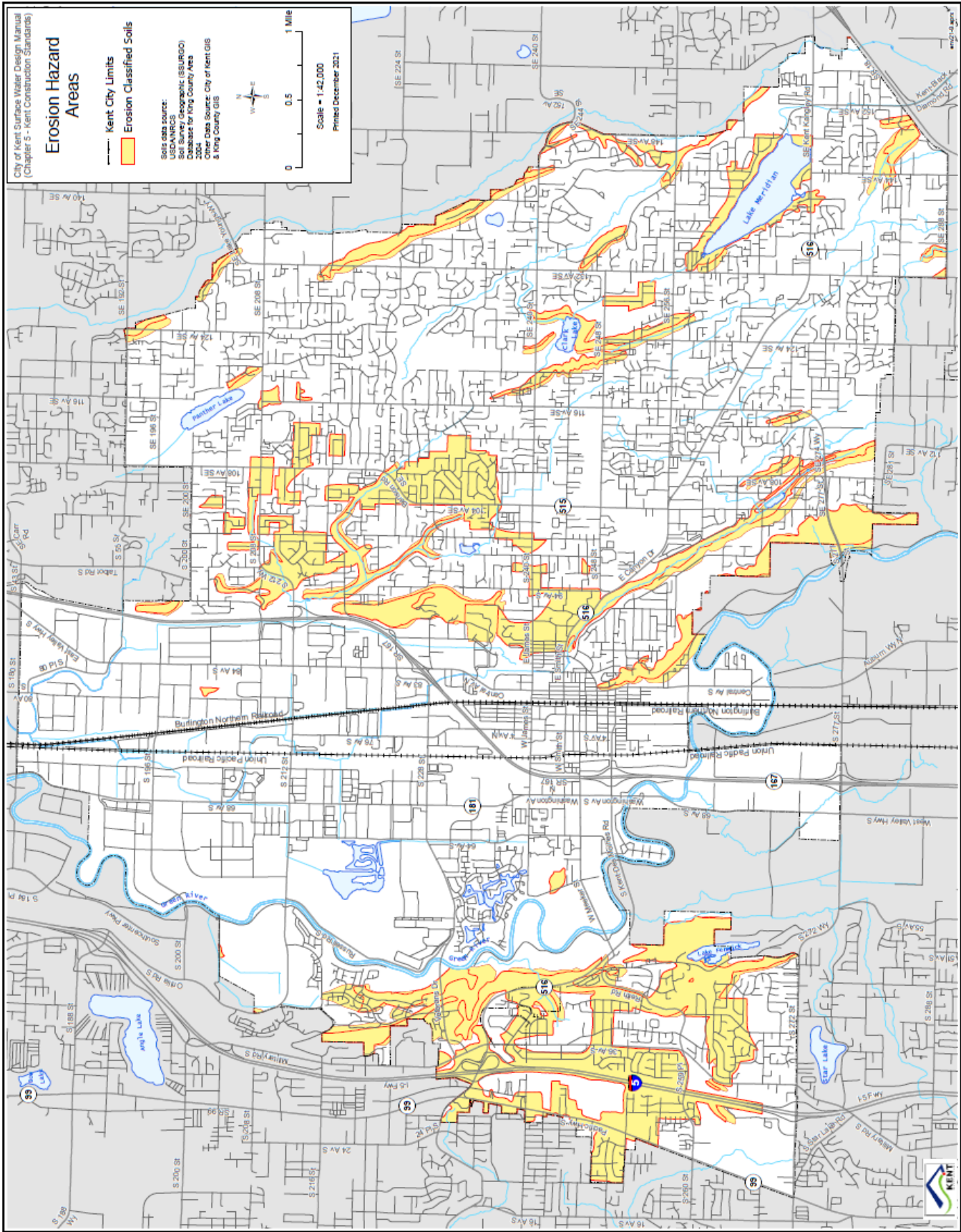

EROSION HAZARD AREAS

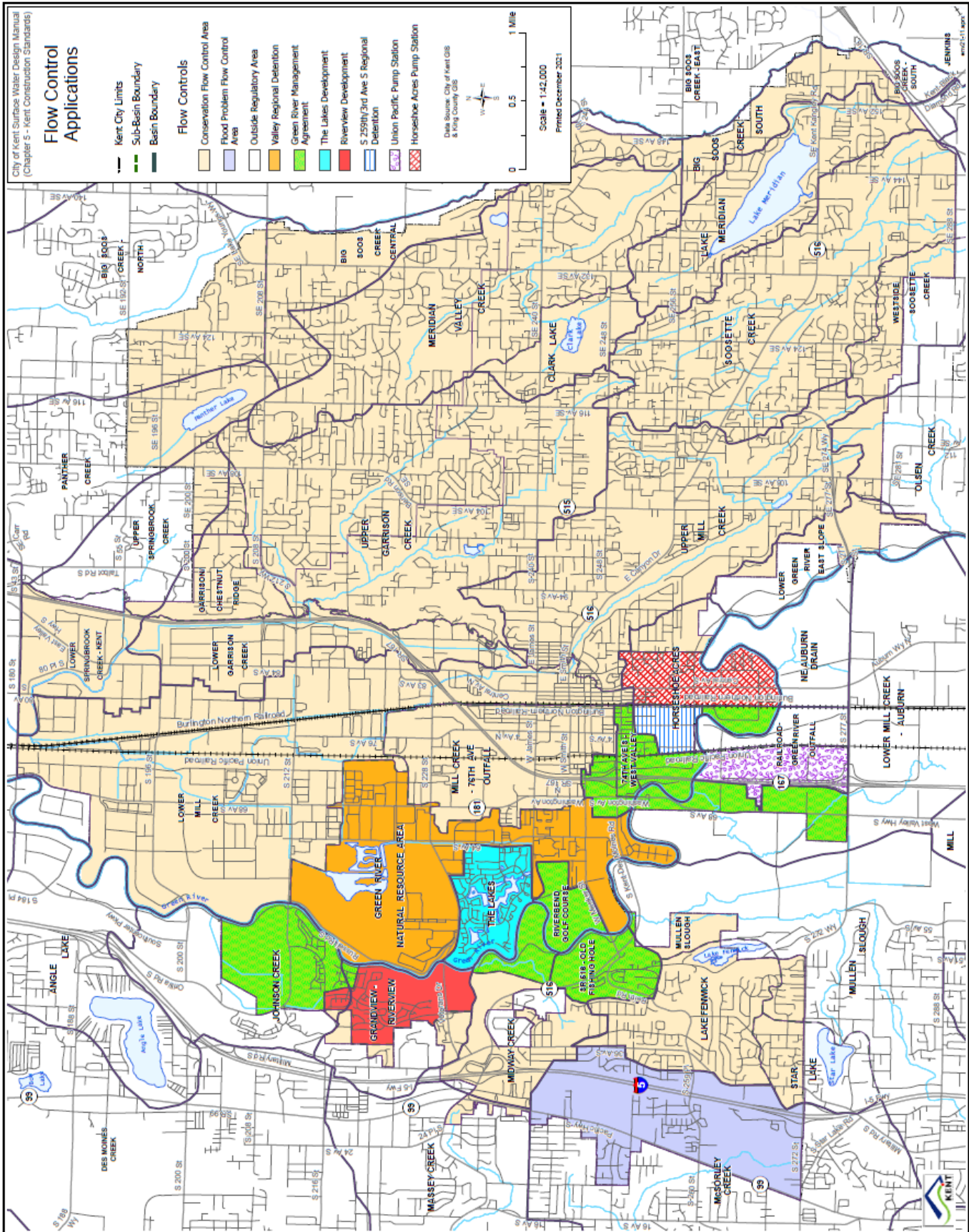

FLOW CONTROL APPLICATIONS

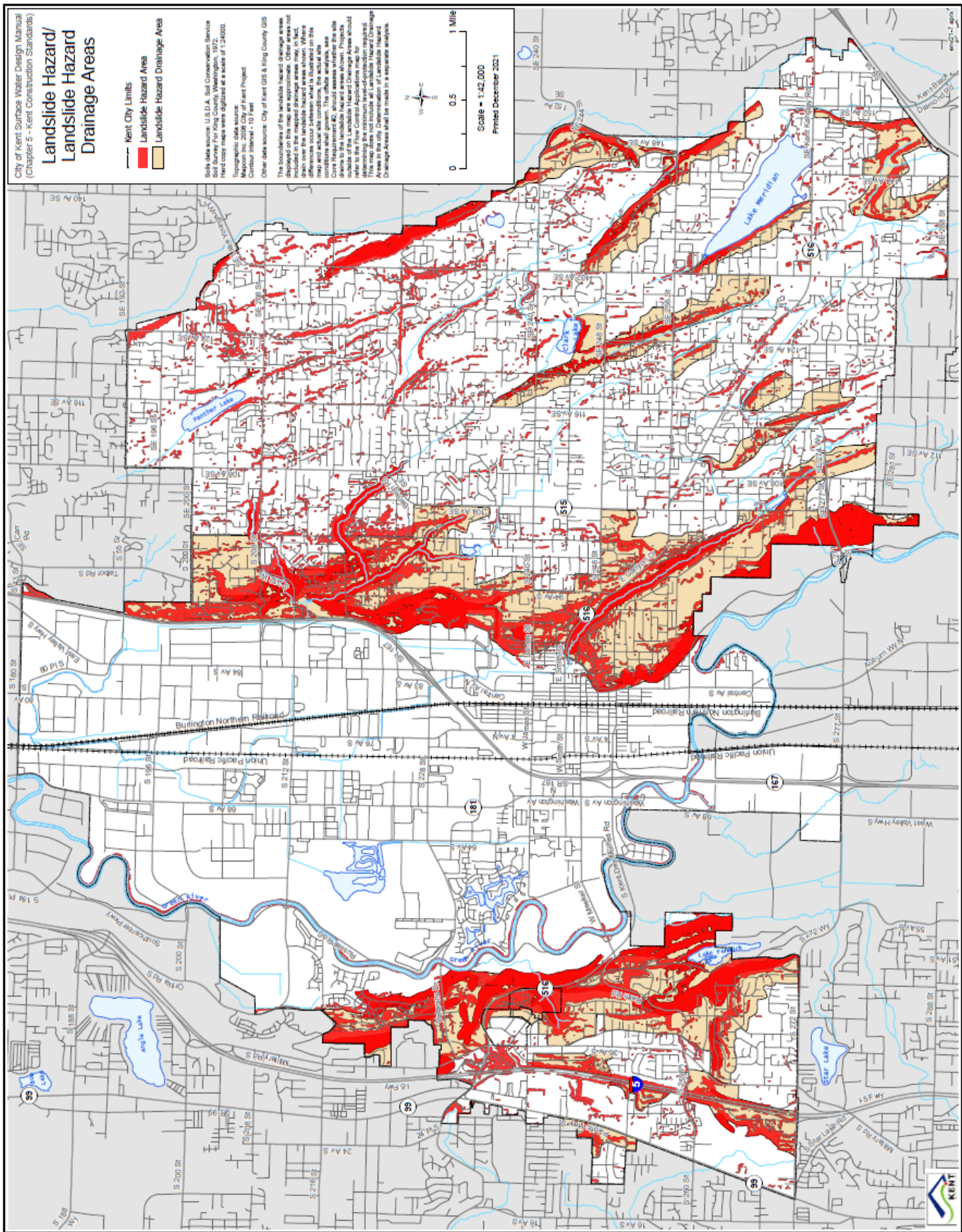

LANDSLIDE HAZARD / LANDSLIDE HAZARD DRAINAGE AREAS

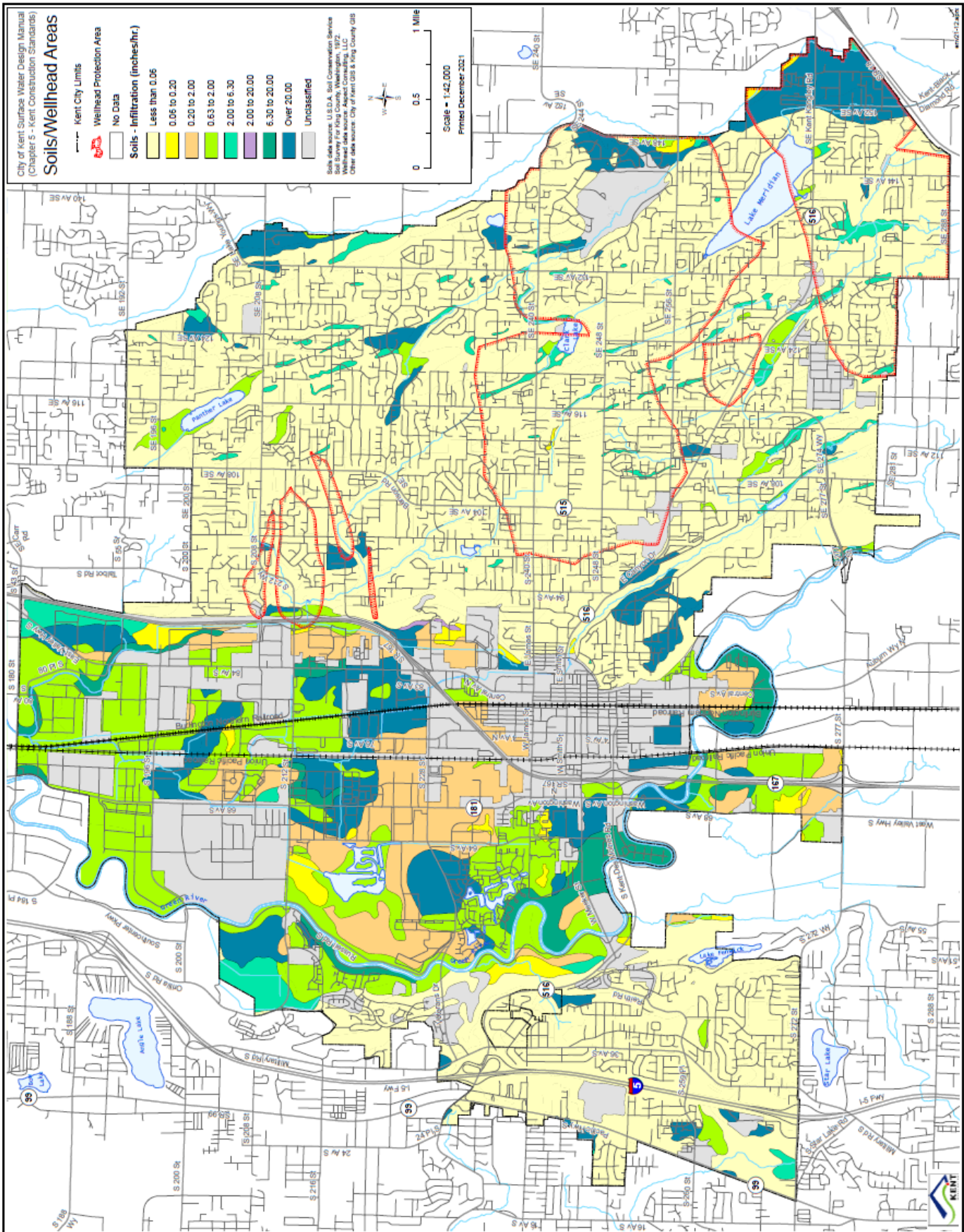

SOILS WELLHEAD AREAS

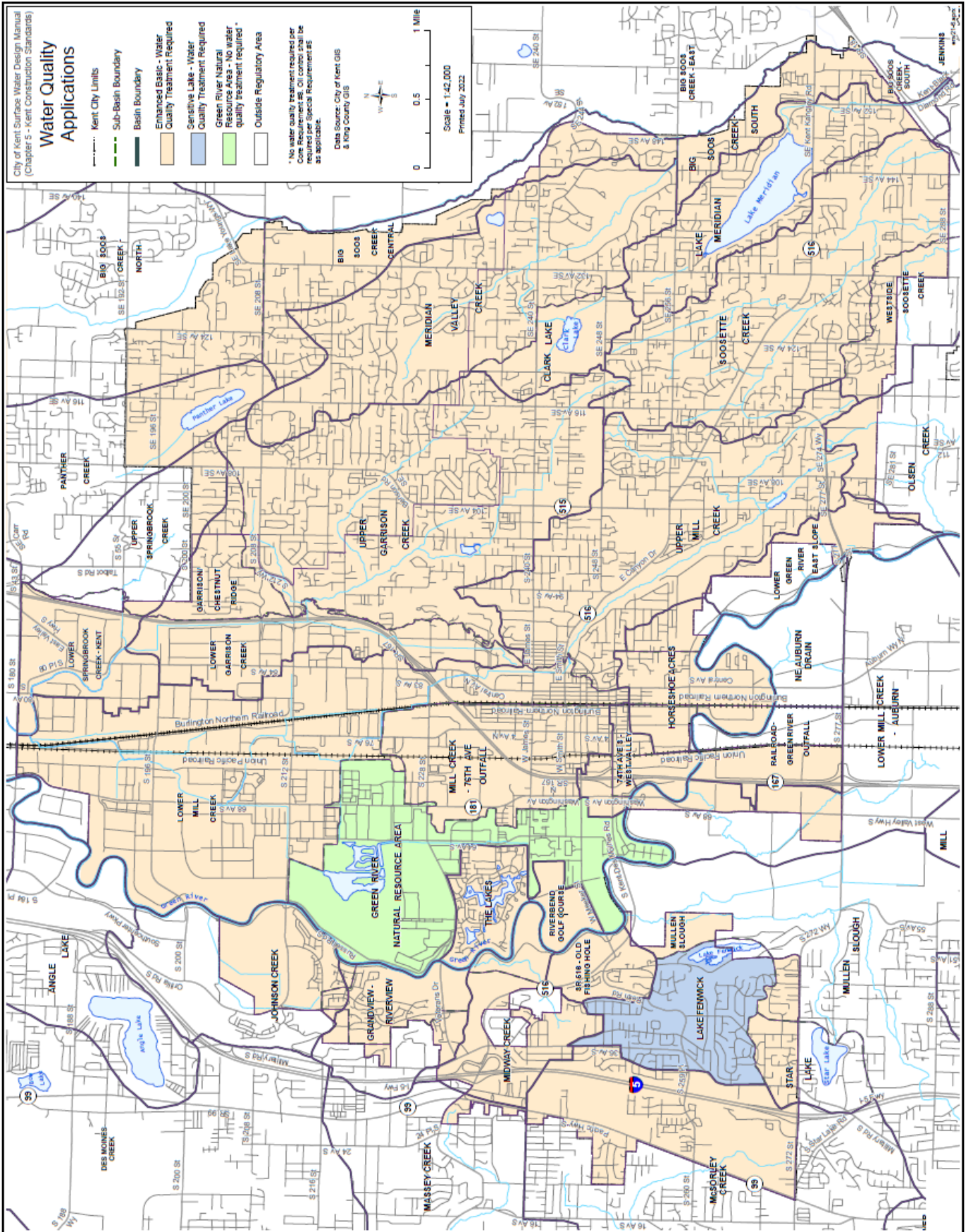

WATER QUALITY APPLICATIONS

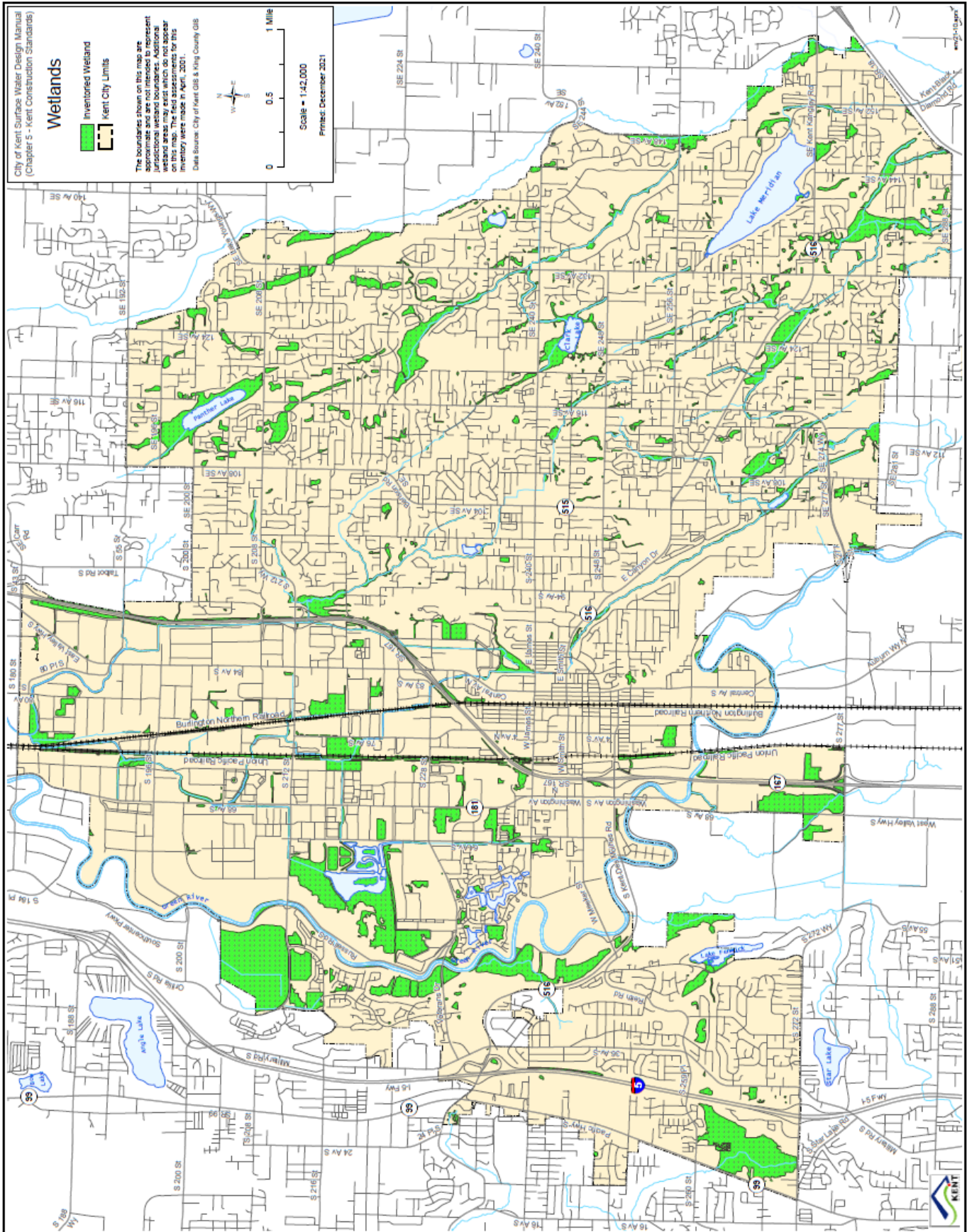

WETLANDS

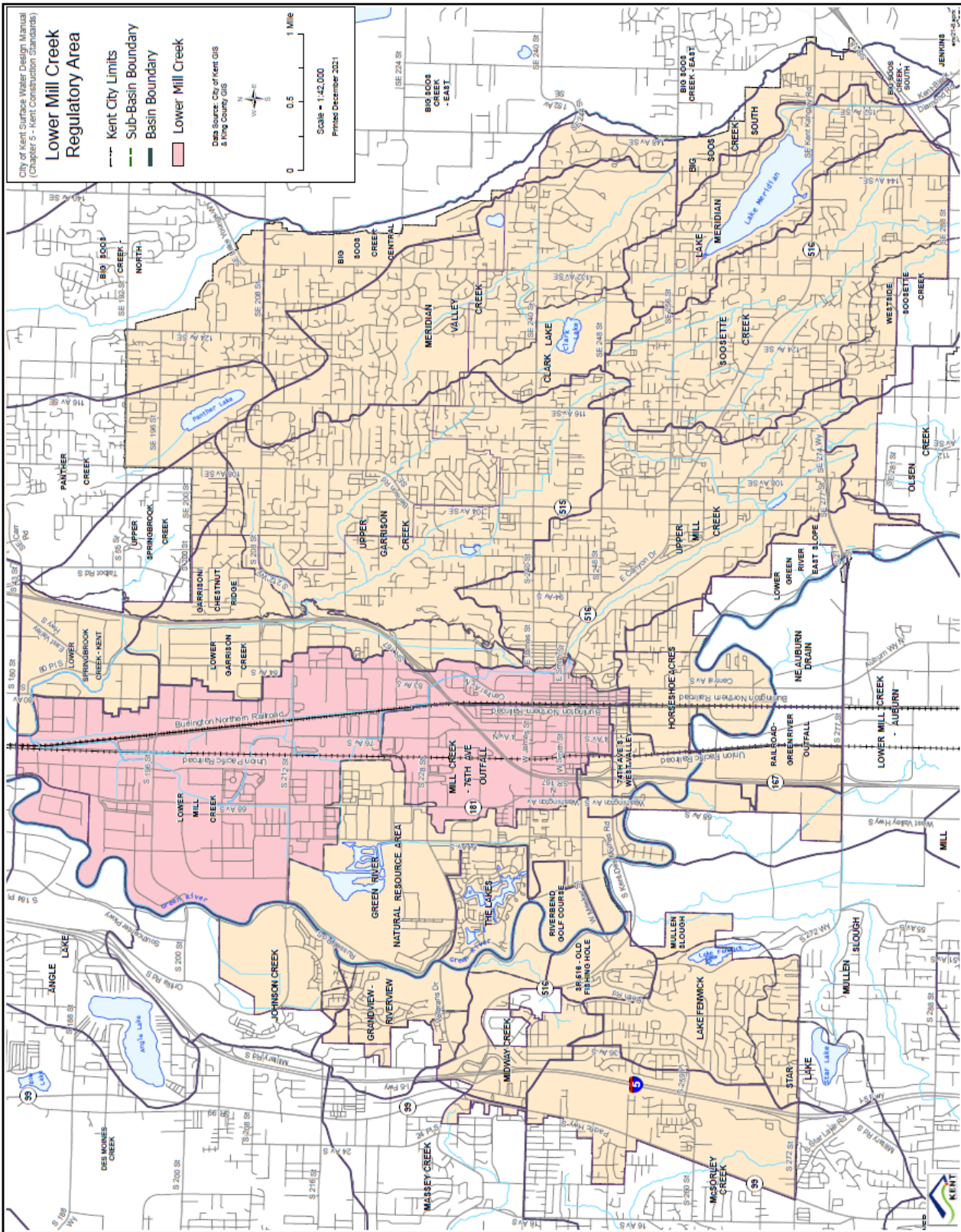

LOWER MILL CREEK REGULATORY AREA

KING COUNTY, WASHINGTON, SURFACE WATER DESIGN MANUAL

FIGURE 3.5.II 100-YEAR 7-DAY ISOPLUVIALS

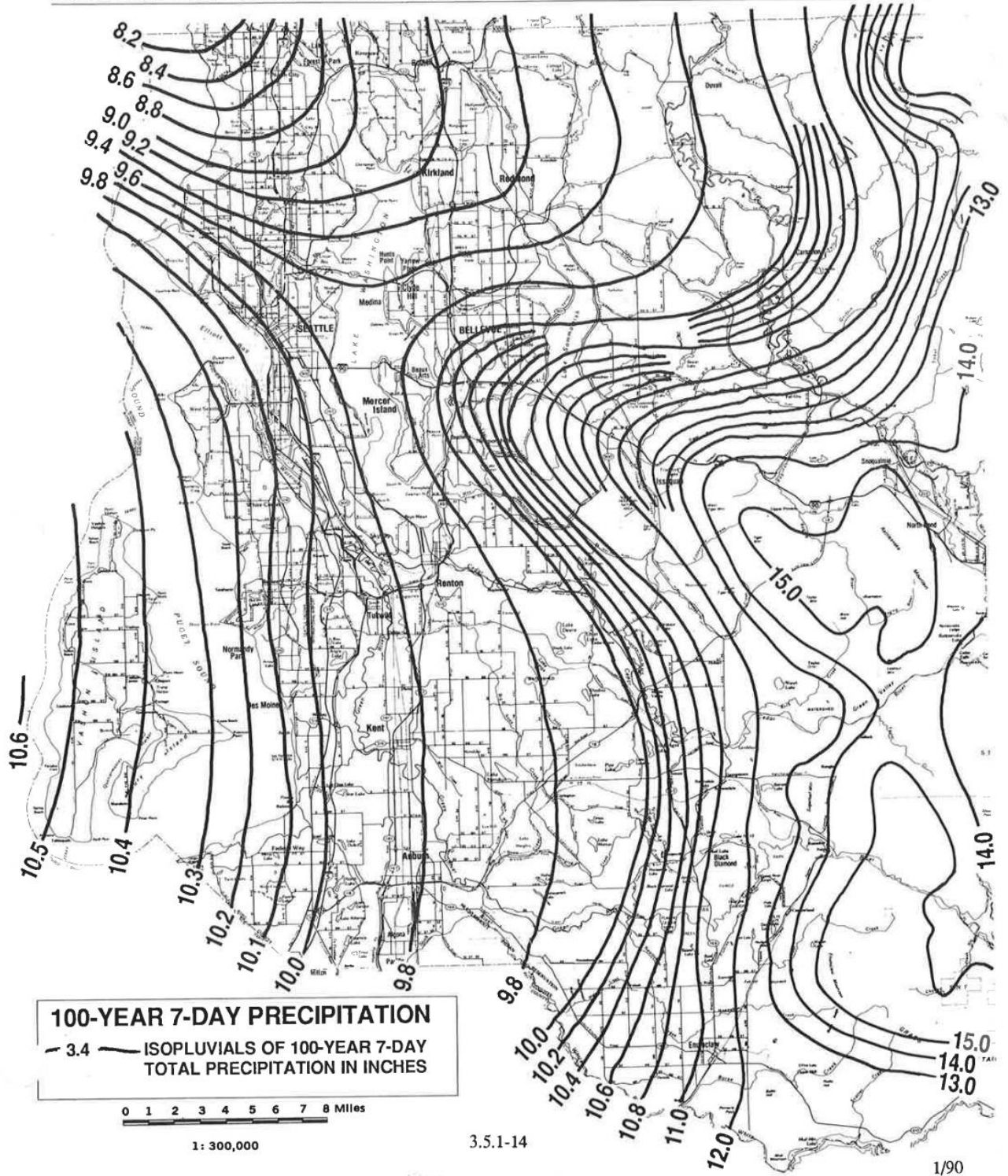

KING COUNTY 100 YEAR 7 DAY ISOPLUVIAL MAP